



Setting the standard
for panel mounting.

Designed for removable panels,
the award winning Fastmount® hidden
mounting system delivers a flawless
finish with perfect alignment every time.

-  MARINE
-  ARCHITECTURE
-  AVIATION
-  RV



Perfect panel mounting. Every time.

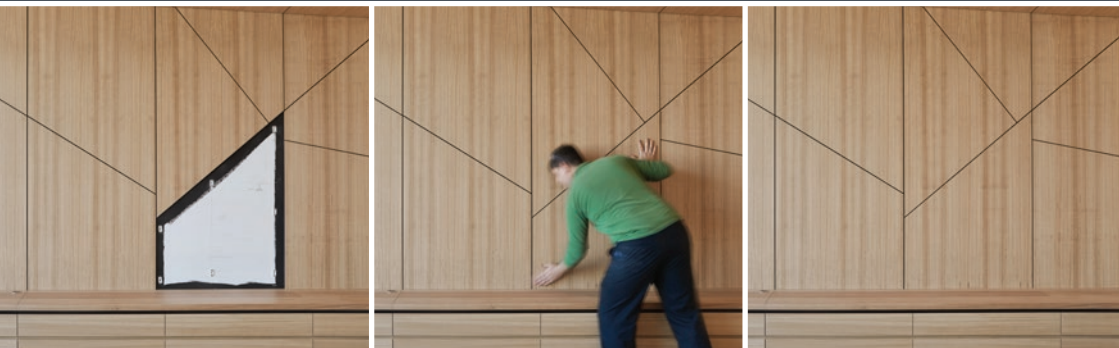

The secret to Fastmount is the unique range of hidden clips ideal for secure fastening of removable panels. With Fastmount, interior panels can be easily removed and refitted in any sequence, time after time.

Combining speed, versatility and accuracy, the Fastmount system enables designers, installers and contractors in the marine, architectural, aviation and RV industries to re-think the panelling process.

Whether you're mounting ceiling panels to wooden framework, heavyweight wall panels to aluminium profiles, or outdoor cushions to a seat, Fastmount has a hidden mounting system to suit your needs.

Fastmount is the original panel mounting solution designed to perform on sea, land and in the air. All of our systems are real world and third-party tested. Applications of use are only limited by your imagination and common sense.

BENEFITS

- No visible fixings
- Allows for repeated removal and replacement of panels
- Eliminates panel damage – install panels during final build stages
- Variety of mounting options – self tapping, glue and screw fix
- Allows for panel flex and expansion
- Provides cavities for services and enhanced acoustics
- Shorter downtime for clients during refit

APPLICATIONS

- Ceilings, walls, feature panels, furniture and upholstery
- Access, inspection and ventilation panels
- Interior and selected exterior applications
- Upholstered, painted, prefinished, composite and acoustic panels
- Mounts into a wide variety of substrates e.g. GRP, composite, honeycomb, aluminium
- New build, refit and upgrades



MARINE



ARCHITECTURE



AVIATION



RV

A solution for every panel.

 Click images to go to page

STANDARD PC RANGE

The Standard Range offers hidden panel mounting solutions for a variety of applications, and includes self-tapping, screw and adhesive fix options. Pull out loads vary from 5-15kg, depending on the male clip used. The Standard Range is ideal for mounting wall and ceiling panels where the standoff between frame and panel does not need to be kept to a minimum. Male and female clips are interchangeable within the range. Common uses: wall and ceiling panels, acoustic panels, prefabricated panels and seat backs.

LOW PROFILE LP RANGE

The Low Profile Range offers self-tapping, screw and adhesive fix clips for mounting wall panels that require less space between panel and substrate. Available in 5-15kg pull out loads depending on the male clip used. The Low Profile Range is ideal for mounting wall panels, with female clips specifically designed to self-tap into curved substrates, drywall and MDF or foam core. Common uses: mounting decorative wall panels to drywall substrates, curved panels to curved walls, and non-upholstered panels to walls.

VERY LOW PROFILE VL RANGE

The Very Low Profile Range offers the least space between panel and substrate, and is suited to very thin substrates and/or panels with no special tools required for installation. Clips can be recessed, screw, rivet or adhesive fixed. Pull-out loads vary from 5-10kg per clip set, with a certified fire-rated version available. Common uses: thin upholstered plywood panels, signage, aluminium honeycomb panels.

METAL MC RANGE

The Metal Range is recommended for more heavy duty applications that require a robust hidden fixing with the innate fire resistance of metal. Self-tapping, screw or rivet and self-adhesive fix options are available, with pull-out loads of 5kg or 10kg depending on female clip used. Common uses: heavyweight wall and ceiling panels, fire-rated panels, metal panels.

STRATLOCK SL RANGE

The Stratlock Range is a heavy-duty panel mounting solution for mounting heavy interior panels onto aluminium or steel extrusion framework, designed specifically for the contract interior fitout industry. With no special installation tools required, the Stratlock Range is a hidden fixing that installs rapidly into the framework and panel, provides supported adjustment of the panel before locking into place, and boasts our highest shear strength and pull out load of 18kg. Typical applications include heavy wall and ceiling panels in the interiors of hotels, hospitals, retail and residential. Patent Pending.

PANELSAFE PS RANGE

PanelSafe restraint systems provide added security and control to panel removal and allow a panel to be suspended below the ceiling for convenient servicing behind the panel or controlled removal of the panel. We recommend the use of a PanelSafe when installing ceiling panels.

TEXTILE TC RANGE

The Textile Range is designed for mounting soft textiles to fabrics and hard surfaces in both interior and exterior settings with clip sets holding up to a 32kg break out load. Utilising a simple slide lock mechanism, the Textile Range offers hidden and secure cushion fastening. Typical applications include sun loungers, exterior cushions on superyachts, seat bases and backs. Patent Pending.



The true and tested way
to frame-up and efficiently
mount panels.

Find out more at fastmount.com/stratlock
or in our Stratlock catalogue

INTRODUCTION

Standard Range	1
Low Profile Range	5
Very Low Profile Range	7
Metal Range	9
Stratlock Range	11
PanelSafe Range	13
Textile Range	15

PRODUCT SHEETS AND INSTALLATION GUIDES

23

Standard Range	23
Low Profile Range	47
Very Low Profile Range	59
Metal Range	63
Stratlock Range	71
PanelSafe Range	85
Textile Range	97

TECHNICAL INFORMATION

105

TD-02 Small or Lightweight Ceiling Panel Layout Guide for All Ranges	107
TD-08 Large Wall Panel Layout Guide for Low Profile Range	108
TD-09 Large Wall Panel Layout Guide for Standard Range	109
TD-12 Heavy or Large Ceiling Panel Layout Guide for Standard and Metal Ranges	110
TD-15 Stratlock Range Layout Guide	111
TD-16 Stratlock Range Layout Guide	112
TD-17 Stratlock Range Layout Guide	113
TD-18 Stratlock Range Layout Guide	114
TD-19 Stratlock Range Layout Guide	115
TD-20 Stratlock Range Layout Guide	116
Selection Guide - Architectural	117
Selection Guide - Marine	119
Panel Offset Guide PC/LP/VL/MC	121
Panel Offset Guide SL/TC	123

ADDITIONAL INFORMATION

125

Frequently Asked Questions	125
Maintenance Guide	127
Fastmount Authorised Distributors	131
Fastmount Range Overview	132

Welcome to Fastmount
panel mounting solutions.



· PC-F1A + PC-M2H

· LP-F8 + LP-M8A

· MC-M5 + MC-F5



Panel mounting solution:
PC-F1A - ceiling panel
PC-M2H - ceiling substrate

LP-F8 - wall panel
LP-M8A - wall substrate

MC-M5 - floor panel
MC-F5 - floor substrate

STANDARD PC RANGE

The Standard Range offers hidden panel mounting solutions for a variety of applications, and includes self-tapping, screw and adhesive fix options. Pull-out loads vary from 5-15kg, depending on the male clip used. The Standard Range is ideal for mounting wall and ceiling panels where the standoff between frame and panel does not need to be kept to a minimum. Male and female clips are interchangeable within the range. Common uses: wall and ceiling panels, acoustic panels, prefabricated panels and seat backs.

PC-M1B STANDARD SELF TAPPING MALE CLIP

Male self tapping clip suitable for most panel types. Mounts into PC-F1A, PC-SF1, PC-RF1 and PC-AF1. 5kg pull out load per clip. Screws into 10mm hole with CT-01 or CT-09. Minimum panel thickness 6mm. Install with CT-10.

See pages 24, 37-44 for more technical details.

PC-M2H STANDARD SELF TAPPING MALE CLIP HEAVY DUTY 10KG

Male self tapping heavy duty clip for thicker panels with increased loading. Mounts into PC-F1A, PC-SF1, PC-RF1 and PC-AF1. 10kg pull out load per clip. Minimum panel thickness 9mm. Screws into 10mm hole with CT-10.

See pages 25, 37-44 for more technical details.

PC-VM1 VARIO SELF TAPPING MALE CLIP 5KG

Male self tapping clip with variable gap and high shear strength. Mounts into PC-F1A, PC-SF1, PC-RF1 and PC-AF1. 5kg pull out load per clip. Minimum panel thickness 9mm. Screws into 10mm hole with CT-10.

See pages 26, 37-44 for more technical details.

PC-VMX VARIO SELF TAPPING MALE CLIP EXTRA HEAVY DUTY 15KG

Male self tapping clip with variable gap and high shear strength. Mounts into PC-F1A, PC-SF1, PC-RF1, PC-AF1. Extra heavy duty clip with 15kg pull out load. Minimum panel thickness 9mm. Screws into 10mm hole with CT-10.

See pages 26, 37-44 for more technical details.

PC-SVMX VARIO SCREW FIX MALE CLIP EXTRA HEAVY DUTY 15KG

Male surface mount, screw fix clip with variable gap and high shear strength. Mounts into PC-F1A, PC-SF1, PC-RF1 and PC-AF1. Extra heavy duty clip with 15kg pull out load and location point on base. Screw fix with 3 x countersink screws (maximum #6). No special tools required for installation.

See pages 29, 37-46 for more technical details.

! NEW

PC-SM2 STANDARD SURFACE MOUNT MALE CLIP

Male surface mount clip with SuperGroove® base for thinner panels. Mounts into PC-F1A, PC-SF1, PC-RF1 and PC-AF1. 5kg pull out load per clip. Glue fix with Fastmount SuperGroove Adhesive. No special tools required for installation. Incorporates the patented SuperGroove system.

See pages 27, 37-44 for more technical details.

 Click images to go to page

PC-SM2H STANDARD SURFACE MOUNT MALE CLIP HEAVY DUTY 10KG

Male surface mount heavy duty clip with SuperGroove base for increased loading. Mounts into PC-F1A, PC-SF1, PC-RF1 and PC-AF1. 10kg pull out load per clip.

Glue fix with Fastmount SuperGroove Adhesive. No special tools required for installation. Incorporates the patented SuperGroove® system.

See pages 28, 37-44 for more technical details.

PC-SM1AC STANDARD SURFACE MOUNT MALE CLIP TRANSLUCENT

FOR ACOUSTIC 2KG Male surface mount clip for use with acoustic panels. Mounts into PC-F1A, PC-SF1 and PC-AF1. Glue fix with Fastmount SuperGroove Adhesive or other suitable epoxy glue. No special tools required for installation.

See pages 35-38, 41-44 for more technical details.

PC-F1A STANDARD SELF TAPPING FEMALE CLIP

Female self tapping clip suitable for most panel mounting applications. Compatible with male clips PC-M1B, PC-M2H, PC-SM2, PC-SM2H, PC-VM1, PC-VMX, PC-SVMX and PC-SM1AC. Screws into 16.8mm hole made with CT-07 or CT-13A, or installs into PC-DC1.

See pages 23, 37, 38, 41-45 for more technical details.

PC-DC1 STANDARD FEMALE ANCHOR

Female adjustable anchor which houses the PC-F1A to enable efficient and secure mounting into drywall or concrete substrates. Allows transverse adjustment on uneven substrates to create a level-mounting surface. To be used with PC-F1A female clip and all Standard Range male clips. Installs with 26mm masonry drill and rubber mallet.

See pages 34, 43-44 for more technical details.

PC-SF1 STANDARD SURFACE MOUNT FEMALE CLIP

Female surface mount screw fix clip for use where a cavity is required. Compatible with male clips PC-M1B, PC-M2H, PC-SM2, PC-SM2H, PC-VM1, PC-VMX, PC-SVMX and PC-SM1AC. Screws onto support frame. No special tools required for installation.

See pages 33, 41-42 for more technical details.

PC-RF1 STANDARD SIDE MOUNT FEMALE CLIP (BROWN)

Female side mounting screw fix clip suitable for various side mounting applications. Compatible with male clips PC-M1B, PC-M2H, PC-SM2, PC-SM2H, PC-VM1, PC-VMX and PC-SVMX.

Screw fix to frame. Use CT-18DG install jig for ceiling applications.

See pages 31, 39-40 for more technical details.

PC-AF1 STANDARD AUTO FIT FEMALE CLIP

Female push fit clip suitable for applications requiring lateral adjustment. Compatible with male clips PC-M1B, PC-M2H, PC-SM2, PC-SM2H, PC-VM1, PC-VMX, PC-SVMX and PC-SM1AC. Screw fix into predrilled 35mm hole. No special tools required for installation.

See page 32 for more technical details.



Click images to go to page

FASTMOUNT TOOLS PC RANGE

CP-01ST



CT-01



CT-09



CT-07



CT-13A



CT-15



CT-03



CT-10



CT-22



CT-09DG



CT-18DG



CT-08



CT-06S



CT-05



CT-05H



CT-17



The secret behind
a perfect finish.

• PC-F1A + PC-M1B



Panel mounting solution:
PC-F1A - substrate
PC-M1B - panel

LOW PROFILE LP RANGE



The Low Profile Range offers self-tapping, screw and adhesive fix clips for mounting wall panels that require less space between panel and substrate. Available in 5-15kg pull out loads depending on the male clip used. The Low Profile Range is ideal for mounting wall panels, with female clips specifically designed to self-tap into curved substrates, drywall and MDF or foam core. Common uses: mounting decorative wall panels to drywall substrates, curved panels to curved walls, and non-upholstered panels to walls.

LP-M8A LOW PROFILE SELF TAPPING MALE CLIP

Male low profile self tapping clip for plywood and MDF type boards. Mounts into LP-F8, LP-DF8 and LP-AF8A. 5kg pull out load per clip. Screws into 10mm hole with CT-09. Install with CT-10. See pages 47-50, 54-55 for more technical details.

LP-SM8AS LOW PROFILE SURFACE MOUNT MALE CLIP

Male low profile surface mount clip with SuperGroove base for thinner panels. Mounts into LP-F8, LP-DF8 and LP-AF8A. 5kg pull out load per clip. Screw or glue fix with Fastmount SuperGroove Adhesive. No special tools required for installation.

See pages 47-49, 51, 53, 55-56 for more technical details.

LP-SMX LOW PROFILE MALE HEAVY DUTY – 15KG

! NEW

Male low profile extra heavy duty surface mount clip for heavy panels. Mounts into LP-F8 and LP-AF8A. 15kg pull out load per clip. Screw fix with 3 x countersink #6 type screws. No special tools required for installation.

See pages 47-48, 52, 57-58 for more technical details.

LP-F8 LOW PROFILE SELF TAPPING FEMALE CLIP

Female low profile self tapping clip for use with plywood and MDF type boards. Compatible with male clips LP-M8A, LP-SM8AS and LP-SMX. Install with CT-19 into 25-25.4mm hole.

See pages 47, 50-55, 57 for more technical details.

LP-DF8 LOW PROFILE SELF TAPPING FEMALE CLIP COARSE THREAD

Female low profile self tapping clip with coarse thread for use with drywall plasterboard and soft core material. Compatible with male clips LP-M8A and LP-SM8AS. Install with CT-19 into 25mm hole.

See pages 49-52, 55-56 for more technical details.

LP-AF8A LOW PROFILE FEMALE CLIP AUTOFIT

Female low profile push fit clip with lateral adjustment designed for use with curved panels. Compatible with male clips LP-M8A, LP-SM8AS and LP-SMX. Screw or glue fix with Fastmount SuperGroove Adhesive into predrilled 35mm hole.

See pages 48, 50-52, 57-58 for more technical details.

 Click images to go to page

 TOOLS

CP-08ST



CT-01



CT-09



CT-10



CT-19



CT-20



CT-22



CT-09DG



LP-08Y



CT-05



CT-05H



CT-17



VERY LOW PROFILE VL RANGE



The Very Low Profile Range offers the least space between panel and substrate, and is suited to very thin substrates and/or panels with no special tools required for installation. Clips can be recessed, screw, rivet or adhesive fixed. Pull-out loads vary from 5-10kg per clip set, with a certified fire-rated version available. Common uses: thin upholstered plywood panels, signage, aluminium honeycomb panels.

VL-M3 VERY LOW PROFILE MALE CLIP

Male very low profile surface mount clip. Compatible with female clip VL-F3. 5kg pull out load per clip set. Screw or glue fix with Fastmount SuperGroove Adhesive. No special tools required for installation.

See pages 59, 61-62 for more technical details.

VL-F3 VERY LOW PROFILE FEMALE CLIP

Female very low profile clip for surface or recessed mounting. Compatible with male clip VL-M3. 5kg pull out load per clip set. Screw or Fastmount SuperGroove Adhesive fix. No special tools required for installation.

See pages 59, 61-62 for more technical details.



VL-SS3 VERY LOW PROFILE STAINLESS STEEL SCREW

Custom type 303 stainless steel screw for fixing VL range clips into panels as thin as 5.5mm. Pozi drive head.

See pages 60-62 for more technical details.

 [Click images to go to page](#)



VL-M3H VERY LOW PROFILE MALE CLIP HEAVY DUTY 10KG

Male very low profile heavy duty surface mount clip. Compatible with female clip VL-F3H. 10 kg pull out load per clip set. Screw or glue fix with Fastmount SuperGroove Adhesive. No special tools required for installation.

See pages 59, 61-62 for more technical details.

VL-F3H VERY LOW PROFILE FEMALE CLIP HEAVY DUTY 10KG

Female very low profile heavy duty clip for surface or recessed mounting. Compatible with male clip VL-M3H. 10kg pull out load per clip set. Screw or glue fix with Fastmount SuperGroove Adhesive. No special tools required for installation.

See pages 59, 61-62 for more technical details.

VL-M3FR VERY LOW PROFILE MALE CLIP FIRE RATED 10KG

Male very low profile fire rated surface mount clip. Compatible with female clip VL-F3FR. 10kg pull out load per clip set. Screw fix with VL-SS3. No special tools required for installation. Fire-resistance certified by CSTB (Scientific and Technical Centre for Building, France)

See page 60, 61 for more technical details.

VL-F3FR VERY LOW PROFILE FEMALE CLIP FIRE RATED 10KG

Female very low profile fire rated clip for surface or recessed mounting. Compatible with male clip VL-M3FR. 10kg pull out load per clip set. Screw fix with VL-SS3. No special tools required for installation. Fire-resistance certified by CSTB (Scientific and Technical Centre for Building, France)

See page 60, 61 for more technical details.

 Click images to go to page

TOOLS

VL-CP3



CT-05



CT-05H



CT-17



METAL RANGE MC RANGE

MC



The Metal Range is recommended for more heavy duty applications that require a robust hidden fixing with the innate fire resistance of metal. Self-tapping, screw or rivet and self-adhesive fix options available, with pull-out loads of 5kg or 10kg depending on female clip used. Common uses: heavyweight wall and ceiling panels, fire-rated panels, metal panels.

MC-M5 METAL SELF TAPPING MALE CLIP

Male self tapping metal clip suitable for fire rated panels. Compatible with MC-F5 (5kg pull out load) and MC-F10 (10kg pull out load). Screws into 10mm hole with CT-09. Install with MC-IT5.

See pages 63-65, 67-68 for more technical details.

MC-F5 SELF TAPPING FEMALE CLIP 5KG

Female metal clip with white centre to indicate 5kg pull out load. Compatible with MC-M5, MC-SM5 and MC-SM5-VHB. Self taps into 13mm hole with MC-IT5. Screw fit installation with #4 gauge screws.

See pages 63-64, 66-70 for more technical details.

MC-F10 METAL SELF TAPPING FEMALE CLIP HEAVY DUTY 10KG

Female metal clip with black centre to indicate 10kg pull out load. Compatible with MC-M5, MC-SM5 and MC-SM5-VHB. Self taps into 13mm hole with MC-IT5. Screw fit installation with #4 gauge screws.

See pages 65-70 for more technical details.

MC-SM5 METAL MALE SURFACE MOUNT – SCREW

! NEW

Male clip with screw fix or rivet fix installation. Fire retardant with stainless steel composition. Compatible with the MC-F5 and MC-F10 depending on pull out load requirement. No special tools required for installation.

See pages 66, 69 for more technical details.

MC-SM5-VHBFR METAL MALE SURFACE MOUNT - ADHESIVE

! NEW

Surface mount male metal clip with fire-rated (VHB-FR) self-adhesive backing. Compatible with the MC-F5 and MC-F10 depending on pull out load requirement. No special tools required for installation.

See pages 66, 70 for more technical details.

 [Click images to go to page](#)

TOOLS

MC-CP5



CT-09



MC-IT5



CT-22



CT-05H



CT-17





Strength,
when you need it.

When you have a heavy duty application that requires fire rating plus heavy load bearing, the Fastmount Metal Range is up to the job. Able to hold up to 50kg per m², heavy panels can be mounted accurately and safely.

STRATLOCK SL RANGE

SL



The Stratlock Range is a heavy-duty panel mounting solution for mounting heavy interior panels onto aluminium or steel extrusion framework, designed specifically for the contract interior fitout industry. With no special installation tools required, the Stratlock Range is a hidden fixing that installs rapidly into the framework and panel, provides supported adjustment of the panel before locking into place, and boasts our highest shear strength and pull out load of 18kg. Typical applications include heavy wall and ceiling panels in the interiors of hotels, hospitals, retail and residential. Patent Pending.

SL-FA/SL-FA-FR STRATLOCK FEMALE SIDE MOUNT

Female side mount clip with twist lock installation into aluminium extrusion. Fits into extrusion channel with dimensions of mouth: 7.5mm - 8.5mm, depth: min. 7mm, wall thickness: 0.75mm - 1.2mm. New solid-style internal load chassis. 10kg pull out load with SL-M10, 18kg with SL-M18. No special tools required for installation.

See pages 71, 75-79 for more technical details.

SL-SFA/SL-SFA-FR STRATLOCK SIDE MOUNT FOR TIMBER FRAMEWORK

Female side mount clip with screw fit installation into timber framework. Recommended for use with timber, steel or aluminium substrates. New solid-style internal load chassis. 10kg pull out load with SL-M10, 18kg with SL-M18. No special tools required for installation.

See pages 73, 75-76, 82 for more technical details.

SL-FB/SL-FB-FR STRATLOCK FEMALE FRONT MOUNT

Female front mount channel insert with push fit installation. Fits into 18mm standard galvanized steel rail framework with channel dimensions of mouth: 35.0mm - 35.75mm, depth: min 15.75mm - 16.5mm. New solid-style internal load chassis. 10kg pull out load with SL-M10, 18kg with SL-M18. No special tools or screws required for installation.

See pages 72, 75-76, 80-81 for more technical details.

SL-FC/SL-FC-FR STRATLOCK FEMALE FLUSH MOUNT

! NEW

Female flush mount clip with screw fit installation. Fits into $\varnothing 40$ mm hole, and screw fixes with 3 x #5 screws. No special tools required for installation.

See pages 74-76, 83-84 for more technical details.

SL-M18/SL-M18-FR STRATLOCK MALE 18KG

Male clip with two-stage engagement for adjustable panel positioning and locking. Fixes to panel with #8 screw, or surface mount with SuperGroove Adhesive. Mounts into SL-FA, SL-SFA, SL-FB and SL-FC. 18kg pull out load. No special tools required for installation.

See pages 71-74, 76-84 for more technical details.

SL-M10 STRATLOCK MALE 10KG

! NEW

Male clip with two-stage engagement for adjustable panel positioning and locking. Fixes to panel with either 1 x #8 screw or 3 x #8 screws; or adhesive fix with Fastmount SuperGroove[®] Adhesive. Mounts into SL-FA, SL-SFA, SL-FB and SL-FC. 10kg pull out load. No special tools required for installation.

See pages 71-84 for more technical details.

 Click images to go to page

 **TOOLS**

CP-01ST





The accuracy of
aluminium framework.

The precision
of Stratlock™.

Panel mounting onto aluminium framework has never been faster or more flexible. The all-new Stratlock system uses a two-stage clip mechanism to provide 4mm of panel adjustment in any direction before locking accurately into position. The result; flexible yet exact alignment with non-sequential panel removal and acoustic isolation.



Patented 360° adjust & lock
positioning function.

! COMING SOON

STRATLOCK RAIL SYSTEM
BY FASTMOUNT

PANELSAFE PS RANGE

PS



PanelSafe restraint systems provide added security and control to panel removal.

With the use of the PanelSafe, a panel can be suspended below the ceiling for convenient servicing behind the panel or controlled removal of the panel. Suitable for use with the PC, LP, VL, MC and SL clip ranges. Ideal for inspection panels, large and/or heavy ceiling panels. To ensure quality installation and performance, installation and removal tools are supplied. Note: custom products have a three week lead time.

PS-150 PANELSAFE 150MM

Suspends panel on removable stainless steel wire strops. Suitable for use in conjunction with any Fastmount ranges. Standard drop length 150mm, with custom lengths available on request. Install with CT-07, CT-03 and CT-10.

See pages 85, 91-92 for more technical details.

PS-150E PANELSAFE EASY FIT SELF TAPPING 150MM

Suspends panel on removable stainless steel wire strops. Suitable for use in conjunction with any of the Fastmount range of clips. Standard drop length 150mm, with custom lengths available on request. Install with CT-10.

See pages 86, 93-94 for more technical details.

PS-S150E PANELSAFE EASY FIT SURFACE MOUNT 150MM

Suspends panel on removable stainless steel wire strops. Suitable for use in conjunction with any of the Fastmount range of clips. Standard drop length 150mm, with custom lengths available on request. Screw or glue fix with Fastmount SuperGroove® Adhesive to panel.

See pages 87, 93-94 for more technical details.

PS-SR225S & PS-SR225SS PANELSAFE SEISMIC RESTRAINT

Seismic restraint available in galvanised or stainless steel with simple screw fix installation. For use with both ceiling and wall panels in high volume applications. Compatible with any range of Fastmount clips. Drop length 225mm.

See pages 88-90, 95-96 for more technical details.

 [Click images to go to page](#)

TOOLS

CT-07



CT-03



CT-10



CT-22



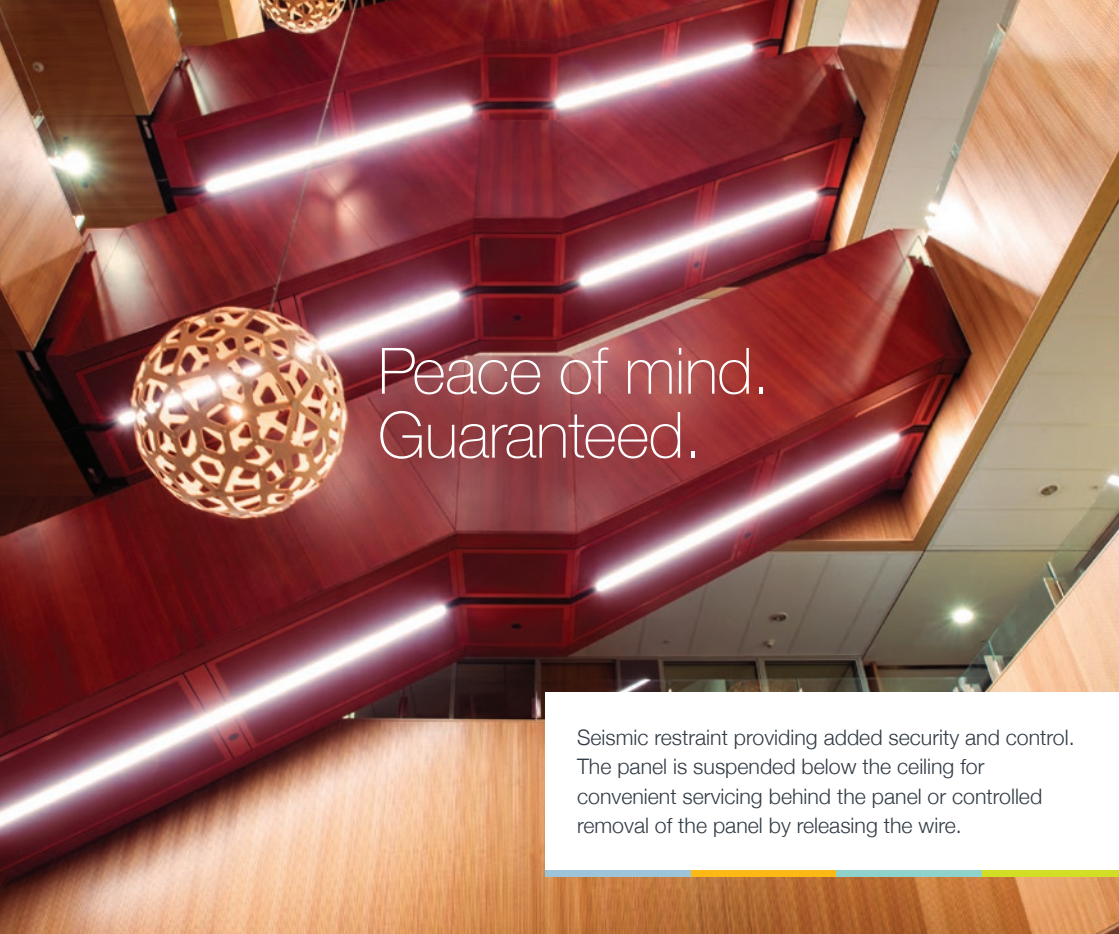

Peace of mind. Guaranteed.

Seismic restraint providing added security and control. The panel is suspended below the ceiling for convenient servicing behind the panel or controlled removal of the panel by releasing the wire.

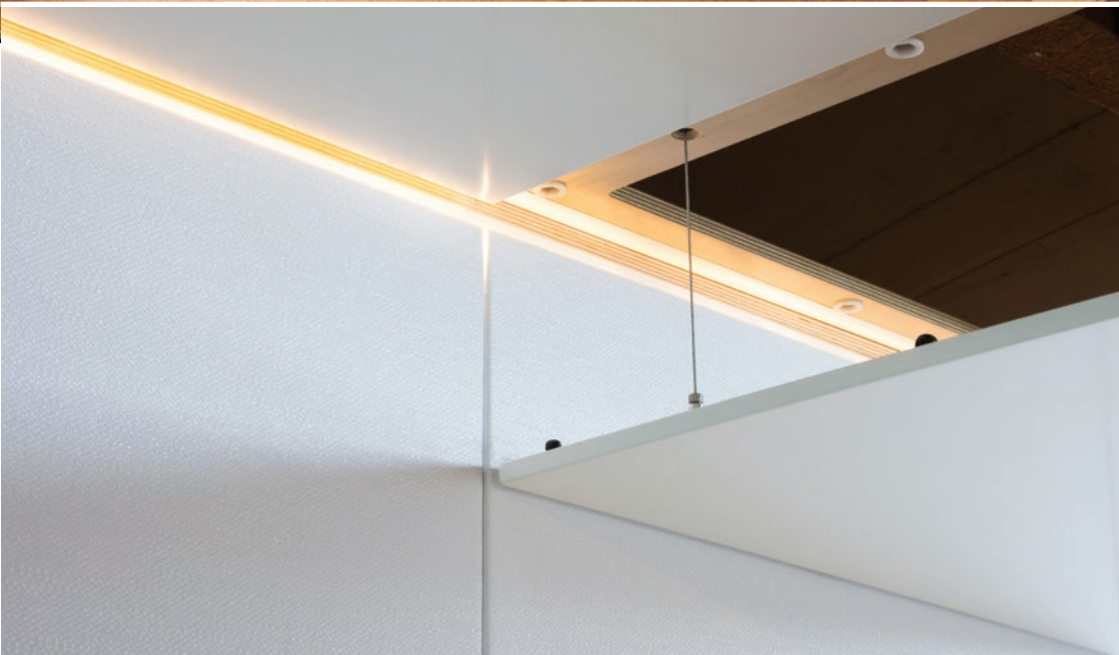

TEXTILE TC RANGE

TC



The Textile Range is designed for mounting soft textiles to fabrics and hard surfaces in both interior and exterior settings with clip sets holding up to a 32kg break out load. Utilising a simple slide lock system, the Textile Range offers hidden and secure cushion fastening. Typical applications include sun loungers, exterior cushions on superyachts, seat bases and backs. Patent Pending.

TC-F6H TEXTILE CLIP FEMALE HEAVY DUTY

Heavy-duty female clip with quick aligning, secure slide-lock function. Stitches onto upholstery during construction process. 26kg pull out load with TC-M6, 32kg pull out load with TC-SM6. No removal tool required. For use with male clips TC-M6, TC-SM6 and TC-SM6S.

See pages 97-104 for more technical details.

TC-M6 TEXTILE CLIP MALE - SCREW FIX

White screw fix male for use with #6 screw. UV resistant. Compatible with TC-F6H.

See pages 97, 99, 103 for more technical details.

TC-SM6 TEXTILE CLIP SELF ADHESIVE MALE CLIP

Self adhesive, white surface mount male with Very High Bond (VHB) tape pre-attached for quick, durable install. Compatible with TC-F6H.

See pages 97, 101-102 for more technical details.

TC-SM6S TEXTILE CLIP MALE - SEW ON

Translucent sew on male clip to be used with TC-F6H for fabric-to-fabric upholstery fixing. UV resistant.

See pages 97-98, 100, 104 for more technical details.

! NEW

 Click images to go to page

T TOOLS

TC-CP6H

Textile range centre point with stainless steel tip to mark hole centre in surface for correct clip alignment.

See install guide page 103.



Soft furnishings,
fitted hard
and fast.



• TC-F6H
+ TC-M6



Panel mounting solution:
TC-F6H - soft textile
TC-M6 - deck

FASTMOUNT TOOLS RANGE



To achieve a quality installation and perfect finish with mounted panels, use the appropriate installation and removal tools below for the different clip ranges.



CP-01ST STANDARD RANGE CENTRE POINT

Standard Profile centre point with stainless steel tip to mark hole centre in panel for correct clip alignment. Fits 10mm blind hole in panel drilled with CT-09; or into PC-F1A, PC-SF1, PC-RF1 and PC-AF1.

See install guides and videos for correct use.



CP-08ST LOW PROFILE CLIP CENTRE POINT

Low Profile centre point with stainless steel tip to mark hole centre in panel for correct clip alignment. Fits into LP-F8, LP-DF8 and LP-AF8A.

See install guides and videos for correct use.



VL-CP3 VERY LOW PROFILE CENTRE POINT

Very Low Profile centre point with stainless steel tip to mark hole centre in panel for correct clip alignment. VL-F3, VL-F3H and VL-F3FR.

See install guides and videos for correct use.



MC-CP5 METAL CLIP CENTRE POINT

Metal Clip Range centre point with stainless steel tip to mark hole centre in panel for correct clip alignment. Fits into MC-F5 and MC-F10.

See install guides and videos for correct use.



TC-CP6H TEXTILE RANGE CENTRE POINT

Textile Range centre point with stainless steel tip to mark hole centre in surface for correct clip alignment. Fits into TC-F6H.

See install guides and videos for correct use.



VL-SS3 VERY LOW PROFILE STAINLESS STEEL SCREW

Custom type 303 stainless steel screw for fixing VL range clips into panels as thin as 5.5mm. Pozi drive head.

See install guides and videos for correct use.



CT-09DG DRILL GAUGE FOR USE WITH CT-09 DRILL BIT

Designed for depth control when blind drilling for Standard and Low Profile Range male clips. Machined aluminium housing, anodised red for durability.

NOTE: Sold separately to CT-09.



CT-01 DRILL 10MM WITH SHOULDER

For use with the Standard Profile and Low Profile ranges. For drilling through panel and creating pilot hole for CT-07.

See install guides and videos for correct use.



CT-09 PANEL DRILL 10MM FORSTNER TYPE

For use with Standard Profile, Low Profile and Metal ranges. For drilling blind holes into the back of panels.

See install guides and video for correct use.



CT-07 CARBIDE TIP STEP DRILL

For use with Standard Profile clip PC-F1A. Tungsten tip drill with 16.8mm diameter for drilling 10mm hole in frame.

See install guides and video for correct use.



CT-13A CARBIDE TIP STEP DRILL – 16.8 DIA FOR PC-F1A

For use with Standard Profile clip PC-F1A. Carbide tip drill with 16.8 diameter for drilling holes into fibreglass, carbon fibre and kevlar laminates.

See install guides and video for correct use.



CT-15 TAP FOR PC-F1A

For use with Standard Profile clip PC-F1A. Tap tool for tapping thread to fit PC-F1A into fibreglass, aluminium or similar. Either drill hole with CT-13A or drill out 10mm hole with CT-07 then tap with CT-15.

See install guides and video for correct use.



CT-22 TAP FOR MALE TAP FOR MALE SELF-TAPPING CLIPS

For tapping thread into hard materials for male clips, PC-M1B, PC-M2H, PC-VM1, PC-VMX, LP-M8A, MC-M5, MC-F5, MC-F10, PS-150, PS-150E (self tapping male end).

See install guides and video for correct use.

FASTMOUNT TOOLS RANGE



CT-03 INSTALL TOOL FOR PC-F1A

For use with Standard Profile clip PC-F1A. Use to install self tapping female PC-F1A with battery drill on correct torque setting.

See install guides and video for correct use.



CT-10 INSTALL TOOL SELF TAPPING MALE CLIPS (ALUMINIUM)

For use with Standard Profile, Low Profile and Panel Control range. Use to install self tapping male PC-M1B, PC-M2H, PC-VM1, PC-VMX, PS-150, PS-150E and LP-M8A with battery drill on correct torque setting.

See install guides and videos for correct use.



CT-19 INSTALL TOOL LOW PROFILE RANGE (ALUMINIUM)

For use with Low Profile range. Aluminium install tool for female clips LP-F8 and LP-DF8 with battery drill on correct torque setting. Ideal for large quantity installations.

See install guides and video for correct use.



CT-12 31MM HSS COUNTERSINK DRILL BIT WITH 10MM SHANK

To be used to countersink entry edge of hole (1-2mm) in hard materials such as MDF, hard plywood, fibre glass, plastic.

Use when drilling holes for PC-M1B, PC-M2H, PC-VM1, PC-VMX, LP-M8A, LP-F8, LP-DF8.



MC-IT5 INSTALL TOOL FOR METAL CLIPS MC-F5 & MC-M5

For use with Metal range. Use to install self tapping male MC-M5, also MC-F5 into plywood or similar with battery drill on correct torque setting.

See install guides and video for correct use.



CT-18DG DRILL GUIDE INSTALLATION JIG FOR PC-RF1

Adjustable drill guide for use with the Standard Profile range. Designed for PC-RF1 mounting options.



CT-05 PANEL REMOVAL TOOL

Stainless steel tool for removing upholstered panels. Not for use with painted panels.



CT-05H PANEL REMOVAL TOOL WITH HOOK

Dual purpose reinforced stainless steel panel removal tool with fold down hook for use with lacquered and/or textured panels.



CT-17 PANEL REMOVAL TOOL PAINTED PANEL (GLASS SUCKER 40KG)

Glass suction cup for removal and handling of painted and prefinished panels.

Two glass suckers required for controlled panel removal.



CT-08 YARD KIT 6 TOOLS

Installation tools for Standard Profile range.

Contains CT-01, CT-03, CT-05, CT-07, CT-09 and CT-10 in plastic box.



LP-08Y YARD KIT LOW PROFILE

For use with Low Profile range. Plastic moulded install tool for female clips LP-F8 and LP-DF8 with battery drill on correct torque setting. For standard use.

See install guides and video for correct use.



CT-06S SERVICE KIT

For on-board and on-site maintenance of the Standard Profile range.

Contains 14 x PC-M1B, 4 x PC-M2H, 4 x PC-SM2, 4 x PC-SM2H, CT-10 installation tool and CT-05 panel removal tool.



CG-50G SUPERGROOVE® ADHESIVE GUN FOR 50ML CARTRIDGE

SuperGroove Adhesive gun for use with CG-5010 SuperGroove Adhesive 50ml cartridge.



CG-5010 SUPERGROOVE® ADHESIVE 50ML

Fastmount SuperGroove Adhesive 50ml twin tube dispenser with self-mixing nozzle for use with Fastmount surface mount clips.

10 minute cure, solvent free, non-toxic, no VOCs, RoHS and REACH compliant, 12 month shelf life. Ideal for large scale installations. Supplied with a self-mixing nozzle for proportional mixing. Additional self-mixing nozzles can be purchased.

Helping to make installation easy.



Hideaway Chair
- Think+Shift

Fastmount clips can be used on wall panels and ceiling panels, as well as seating, headboards and inspection hatches. Any place where panels are required to be fitted with removable option and invisible fixings.

The following pages show Product Sheets and Installation Guides to assist with technical support.

There are six ranges of Fastmount clips designed for different applications with various pull-out load options. If you need help choosing the right system for your project, our technical team can assist you.

Find your closest authorised distributor on page 131 or send details of your project with panel type, size, weight and substrate to technical@fastmount.com for further support.

All installation guides are available for download in PDF format at fastmount.com, where step-by-step installation videos are also available to view.



The Standard range,
for a finish that's anything
but standard.



Panel mounting solution:
PC-F1A - substrate
PC-M2H - panel

STANDARD PC RANGE

PC-F1A Self Tapping Female



SPECIFICATIONS:

STANDARD RANGE

The versatile self-tapping PC-F1A female clip is designed to be installed into a variety of substrates, and be combined with any of the male clips in the Standard Range. Male clips determine pull-out loads, which range from 2 - 15kg per clip set. Refer to Clip Layout Guides for recommended clip spacing.



MATERIAL:
White acetal copolymer

MORE INFO:
Installation Guide PC-F1A, PC-DC1
Clip Layout Guide TD-02, 09, 12
Panel Offset Guide

BENEFITS

- Self-aligning installation without adhesives
- Perfect panel alignment and secure mounting every time
- Remove and refit panels in any sequence multiple times
- Saves time and reduces cost
- Option of 2kg, 5kg, 10kg, or 15kg pull out load per clip set
- Allows for flexing and expansion of panel and support frame

APPLICATIONS

- Covered, painted and prefinished panels
- Ceiling and wall panels
- Exterior deckhead panels (marine only)
- Refits and upgrades of existing installations
- Variety of substrates
- Composites and thin-walled panels
- Fits into PC-DC1 for installation into drywall and concrete

INSTALLATION: Partially exploded through section showing typical installation method

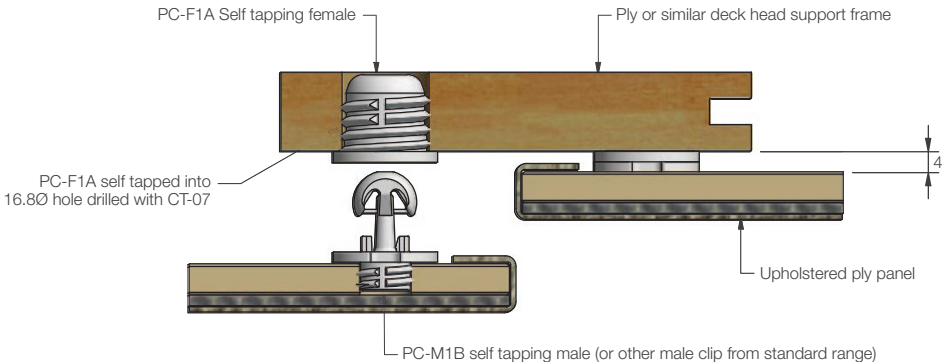

PC

PRODUCT SHEET

PC-M1B Self-tapping male - 5kg



SPECIFICATIONS:

STANDARD PC RANGE

The self-tapping male PC-M1B is a versatile clip that works with all female clips in the Standard Range, and is suitable for various panel mounting applications. With a 5kg pull out load, the PC-M1B is suitable for small and medium weight wall panels. Refer to Panel Offset Guide for gap between substrate and panel, pull out and shear loads.

BENEFITS

- Self-aligning installation without adhesives
- Perfect panel alignment secure mounting every time
- Remove and refit panels in any sequence 100+ times
- Saves time and reduces cost
- Allows for flexing and expansion of panel and support frame materials
- 5kg pull out load

APPLICATIONS

- Covered or painted panels with minimum 8mm thickness
- Ceiling and wall panels
- Refits and upgrades of existing installation
- Variety of substrates

PC-M1B



USE WITH:

PC-F1A



PC-RF1



PC-SF1



PC-AF1



MATERIAL:

White acetal copolymer

MORE INFO:

Installation Guide PC-F1A, SF1, RF1
Clip Layout Guide TD-02, 09, 12
Panel Offset Guide

INSTALLATION: Partially exploded through section showing typical installation method

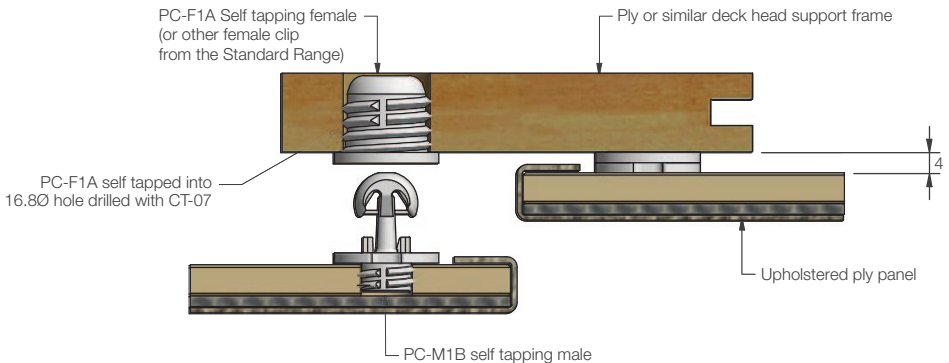

STANDARD PC RANGE

PC-M2H Self Tapping Male - 10kg



SPECIFICATIONS:

The heavy duty self tapping clip, PC-M2H adds to the Standard Range. Specifically designed for thicker panels with increased loading requirements, where PC-M1B is not strong enough, with a 10kg pull out load per clip set. Compatible with all female clips in the Standard Range, and installs into panels with a minimum 8mm thickness.

STANDARD PC RANGE

PC-M2H 10kg

USE WITH:

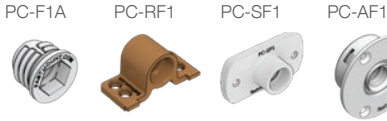

BENEFITS

- Self-aligning installation without adhesives
- Perfect panel alignment secure mounting every time
- Remove and refit panels in any sequence 100+ times
- Saves time and reduces cost
- 10kg pull out load per clip
- Allows for flexing and expansion of panel and support frame materials

MATERIAL:

Black acetal copolymer

MORE INFO:

Installation Guide PC-F1A, SF1, RF1
Clip Layout Guide TD-02, 09, 12

APPLICATIONS

- Covered or painted panels with minimum 8mm thickness
- Ceiling and wall panels
- Exterior deckhead panels (marine only)
- Refits and upgrades of existing installation
- Variety of substrates

INSTALLATION: Partially exploded through section showing typical installation method

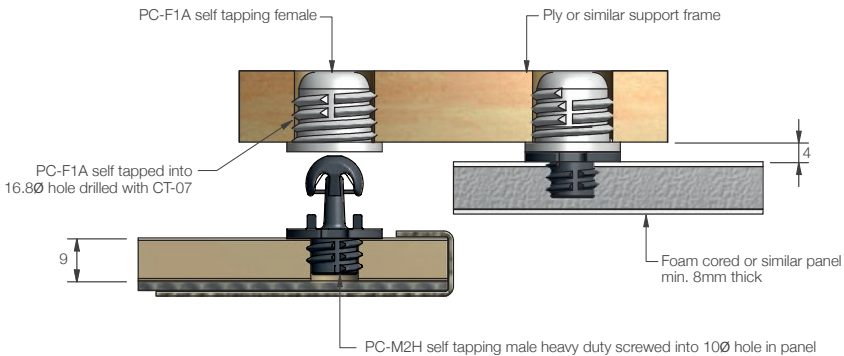

PC

PRODUCT SHEET

PC-VM1 & PC-VMX Vario Clip Self Tapping male - 5 & 15kg



SPECIFICATIONS:

STANDARD PC RANGE

The self-tapping clip PC-VM1 and PC-VMX add to the Standard Range, offering 5kg and 15kg pull out loads respectively. Designed for variable gap, high shear strength applications. Variable gap measurements are 6.5mm at first engagement, 4mm at second engagement. Compatible with all female clips in the Standard Range.

PC-VM1



USE WITH:

PC-F1A

PC-RF1

PC-SF1

PC-AF1



PC-VMX 15kg



MATERIAL:

Acetal copolymer/Nylon GF

MORE INFO:

Installation Guide PC-F1A, SF1, RF1
Clip Layout Guide TD-02, TD-08
Panel Offset Guide

BENEFITS

- Variable clipping depth
- High shear load (See Panel Offset Guide)
- Remove and refit panels in any sequence multiple times
- Perfect panel alignment and secure mounting every time
- 5kg or 15kg pull out load per clip
- Durable design for frequent handling

APPLICATIONS

- Seat backs and bases
- Seat backs with removable covers
- Heavy wall panels
- Use in conjunction with Standard Range clips
- Variety of substrates

INSTALLATION: Partially exploded through section showing typical installation method

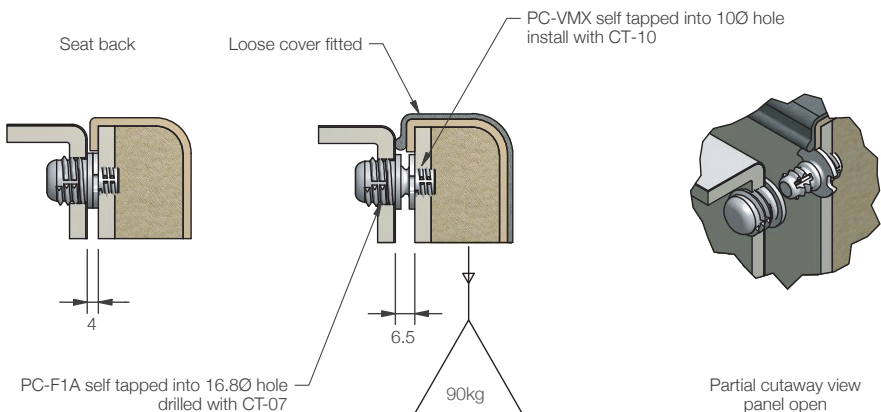

STANDARD PC RANGE

PC-SM2 Surface Mount Male Adhesive Fix - 5kg



SPECIFICATIONS:

The PC-SM2 surface mount male is designed for use with thin walled panels and where installers prefer an adhesive fix. It is ideal for new composite materials. Patented SuperGroove® base mechanically engages into Fastmount SuperGroove Adhesive on the base for secure mounting. Compatible with all female clips in the Standard Range, and has a 5kg pull out load. Refer to Panel Offset Guide for information about gap between substrate and panel, pull out and shear loads.

STANDARD PC RANGE

PC-SM2



USE WITH:

PC-F1A PC-RF1 PC-SF1 PC-AF1



MATERIAL:

White acetal copolymer

MORE INFO:

Installation Guide PC-F1A, SF1, RF1
Clip Layout Guide TD-02, 09, 12
Panel Offset Guide

BENEFITS

- Self-aligning secure mounting (5kg per clip)
- Installation requires no special tools or skilled labour
- Uses Fastmount SuperGroove Adhesive
- No drilling of panels, fast installation
- Works with existing Fastmount clips
- Allows for flexing and expansion of panel and support frame

APPLICATIONS

- Mounting thin walled panels less than 6mm thick
- Soft or honeycomb cored panels with thin facings
- Mounting panels where no drilling is preferred
- Ideal for refit

INSTALLATION: Partially exploded through section showing typical installation method

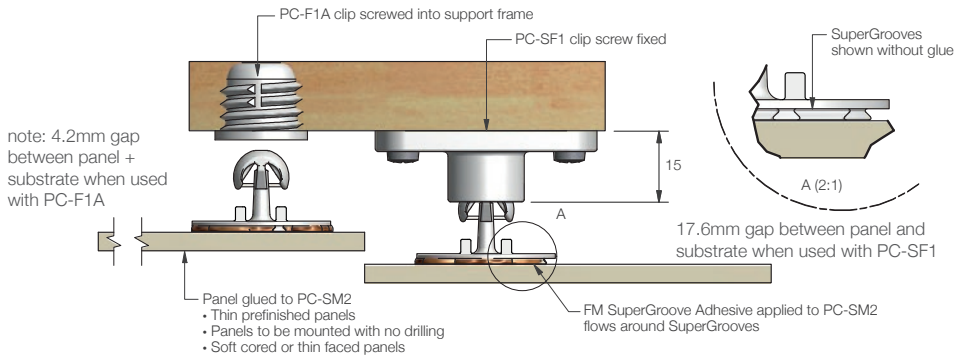

PC-SM2H Surface Mount Male Adhesive Fix -10kg



SPECIFICATIONS:

STANDARD PC RANGE

The PC-SM2H heavy duty surface mount male is designed for use where installers prefer an adhesive fix, and an increased pull out load. It is ideal for new composite materials. Patented SuperGrooves® mechanically engage into Fastmount SuperGroove Adhesive for secure mounting. Compatible with all female clips in the Standard Range, and has a 10kg pull out load. Refer to Panel Offset Guide for information about gap between substrate and panel, pull out and shear loads.

BENEFITS

- Self-aligning secure mounting (min.10kg per clip)
- Installation requires no special tools
- Uses Fastmount SuperGroove Adhesive
- No drilling of panels, fast installation
- Works with existing Fastmount clips
- Allows for flexing and expansion of panel and support frame materials

APPLICATIONS

- Mounting thicker panels with increased loading
- Soft or honeycomb cored panels with thin facings
- Mounting panels where no drilling is preferred
- Ideal for refit

PC-SM2H 10kg

USE WITH:

PC-F1A

PC-RF1

PC-SF1

PC-AF1



MATERIAL:

Black acetal copolymer

MORE INFO:

Installation Guide PC-F1A, SF1, RF1
Clip Layout Guide TD-02, 09, 12
Panel Offset Guide

INSTALLATION: Partially exploded through section showing typical installation method

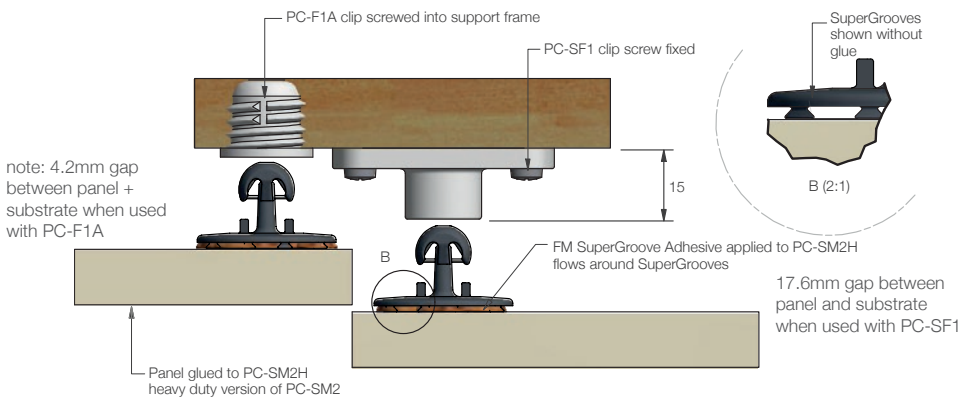

STANDARD PC RANGE

PC

PRODUCT SHEET

PC-SVMX Vario Surface Mount Male Screw Fix – 15kg



SPECIFICATIONS:

The PC-SVMX adds a high shear strength, extra heavy duty option to the Standard Range with a screw fix installation method, removing the need for special installation tools. With a 15kg pull out load, the clip is designed for mounting ceiling or heavyweight wall panels, and has a double detent safety feature providing two stages of clip engagement into the female clip. Can be paired with the PC-SF1, PC-RF1 and PC-AF1 for panel installation without special tools and is also compatible with the PC-F1A. The PC-SVMX features an inbuilt location point on the back of the clip which allows the installer to mark the male clip location on the panel without using a centrepoint (note: use CP-01ST with very hard panels e.g. HPL). See installation guide for more details.

PC-SVMX 15kg

USE WITH:

PC-F1A

PC-RF1

PC-SF1

PC-AF1



! NEW



MATERIAL:
Black acetal
copolymer

MORE INFO:
Installation Guide PC-F1A, SF1, RF1
Clip Layout Guide TD-02, 09, 12
Panel Offset Guide

STANDARD PC RANGE

BENEFITS

- Invisible panel fixing
- No special tools required for installation
- Extra heavy duty 15kg pull out load
- 100kg shear load
- Durable head shape, ideal for pre-fabrication
- Perfect panel alignment
- Rapid installation
- In-built centrepoint
- CNC machine compatible

APPLICATIONS

- Heavyweight wall panels
- Ceiling panels
- Pre-fabricated panels
- Architectural interiors
- Marine interiors

INSTALLATION: Partially exploded through section showing typical installation method

17.4mm gap between panel and substrate when used with PC-F1A

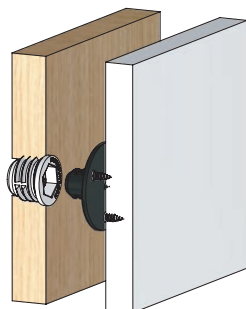

PC-F1A self-tapped
into substrate



Heavyweight
wall panel

Substrate ply / MDF / fibreglass

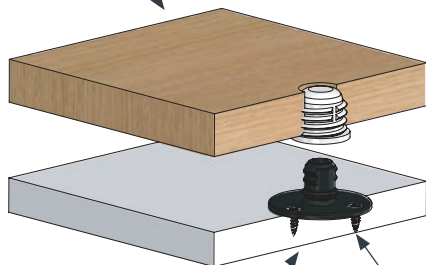

PC-SVMX screwed
into heavyweight
ceiling panel

3 x CSK
#6 screws

Panelling,
limited only by
your imagination.



Panel mounting solution:
PC-F1A - substrate
PC-VMX - panel

STANDARD PC RANGE

PC-RF1 Side Mount Female Screw Fix



SPECIFICATIONS:

The PC-RF1 is ideal for applications that require side mounting, such as refit, cabinet construction or securing floor panels. This versatile screw-fixed clip works with all male clips from the Standard Range. Compatible with all male clips in the Standard Range (pull out load depends on male clip used). Refer to Panel Offset Guide for information about gap between substrate and panel, pull out and shear loads.

PC-RF1

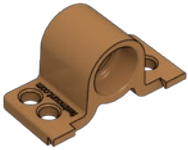

USE WITH:

PC-M1B

PC-VM1

PC-SM2



PC-M2H

PC-VMX

PC-SVMX

PC-SM2H



MATERIAL:

Brown acetal copolymer

MORE INFO:

Installation Guide PC-RF1
Clip Layout Guide TD-02, 09, 12

STANDARD PC RANGE

BENEFITS

- Side mounting
- Installation requires no special tools
- Screw fixed to frame
- Several mounting options
- Compatible with all male Standard Range clips
- Allows for flexing and expansion of panel and support

APPLICATIONS

- Ceiling and wall panels
- Cabinet assembly and shelf support
- Refits and upgrades of existing installations
- Variety of substrates
- Floor panels
- Inspection hatches

INSTALLATION: Partially exploded through section showing typical installation method

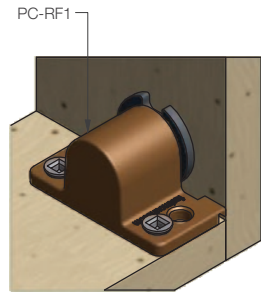
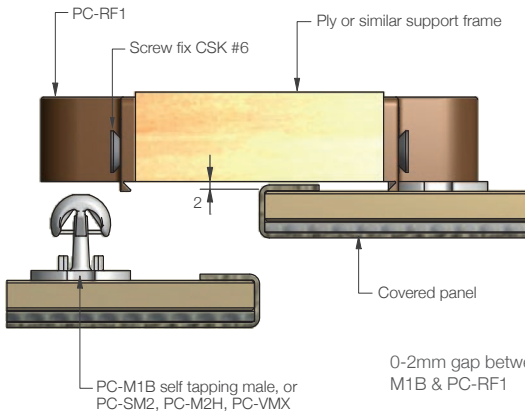

Corner detail at cabinet or shelf

PC

PRODUCT SHEET

PC-AF1 Autofit Female



SPECIFICATIONS:

The Fastmount autofit PC-AF1 is ideal for applications that require lateral adjustment, such as curved panels. This versatile screw-fixed clip is compatible with all male clips in the Standard Range (pull out load depends on male clip used). Refer to Panel Offset Guide for information about gap between substrate and panel, pull out and shear loads.

STANDARD PC RANGE

PC-AF1



USE WITH:

PC-M1B



PC-VM1



PC-M2H



PC-VMX



PC-SM2



PC-SM2H



PC-SVMX



PC-SM1AC



MATERIAL:

White acetal copolymer

MORE INFO:

Clip Layout Guide - TD-02, 09, 12
Panel Offset Guide

BENEFITS

- Lateral panel adjustment in all directions
- Installation requires no special tools
- Push fit into 35Ø hole
- Several mounting options
- Compatible with Standard Range male clips

APPLICATIONS

- Complex shaped panels where lateral adjustment is required
- Ceiling and wall panels
- Mounting of curved panels
- Variety of substrates
- Moulded into hull

INSTALLATION: Partially exploded through section showing typical installation method

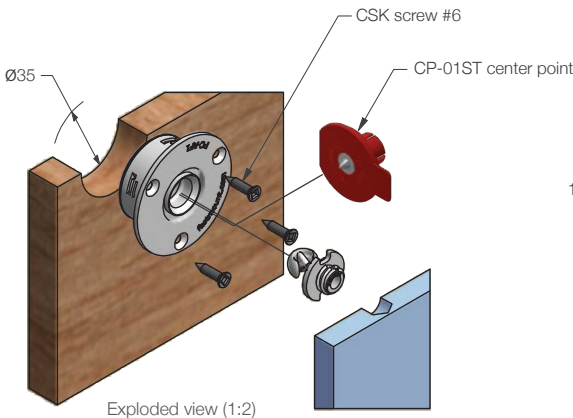

Exploded view (1:2)

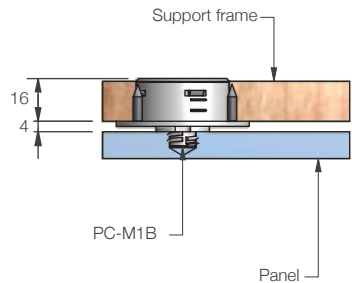

Typical section (1:2)

STANDARD PC RANGE

PC-SF1 Surface Mount Female Screw Fix



SPECIFICATIONS:

The PC-SF1 surface mount female has been designed specifically for use where a cavity is required or where installers prefer a screw-fixed mounting. Compatible with all male clips in the Standard Range (pull out load depends on male clip used). Refer to Panel Offset Guide for information about gap between substrate and panel, pull out and shear loads.

STANDARD PC RANGE

PC-SF1



USE WITH:

PC-M1B



PC-VM1



PC-M2H



PC-VMX



PC-SM2



PC-SM2H



PC-SVMX



PC-SM1AC



MATERIAL:

White acetal copolymer

MORE INFO:

Installation Guide PC-SF1
Clip Layout Guide TD-02, 09, 12
Panel Offset Guide

BENEFITS

- Several mounting options
- Screw fixed to support frame
- Installation requires no special tools
- Works with Standard Range Fastmount clips
- Allows for flexing and expansion of panel and support frame

APPLICATIONS

- Mounting onto aluminium frames
- Mounting onto fire rated cabins
- Mounting panels where a cavity between panel and frame is required
- PC-SF1 can be used on panel or support frame side

INSTALLATION: Partially exploded through section showing typical installation method

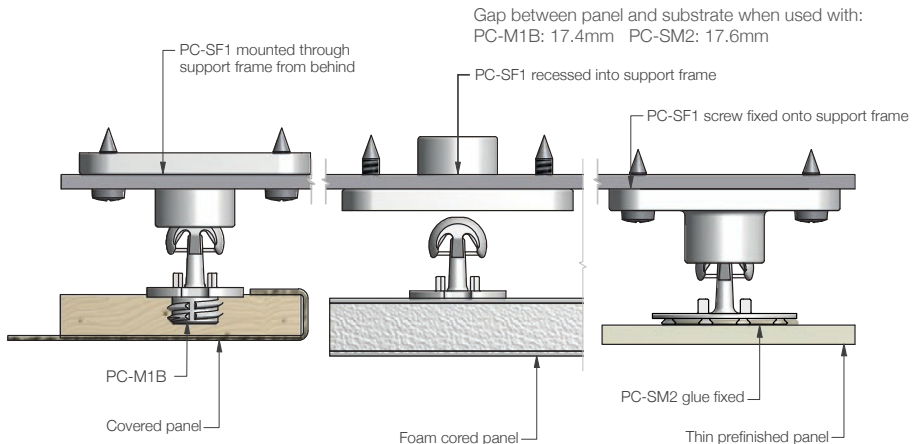

PC-DC1 Female Anchor**SPECIFICATIONS:****STANDARD PC RANGE**

The PC-DC1 is an adjustable female anchor which houses the PC-F1A to enable efficient mounting into drywall or concrete substrates. Features a self-tapping installation for drywall and the option rubber hammer-set into predrilled hole in concrete or brick. Allows transverse adjustment on uneven substrates to create a level-mounting surface. Once PC-F1A is installed into the PC-DC1, the set can be used with any male clip in the Standard Range. Refer to Panel Offset Guide for information about gap between substrate and panel, pull out and shear loads.

PC-DC1**USE WITH:**

PC-M1B

PC-VM1

PC-M2H

PC-VMX



PC-SM2

PC-SM2H

PC-SVMX

PC-SM1AC

**PAIRS WITH:**
PC-F1A**MATERIAL:**

White acetal copolymer

MORE INFO:Installation Guide PC-DC1
Clip Layout Guide TD-09
Panel Offset Guide**BENEFITS**

- Quick to install
- No framework required when mounting to concrete walls
- Adjustable gap between wall and panel (4.5mm - 10.5mm) depending on PC-F1A adjustment
- Minimal standoff of 4.5mm between wall and panel
- Transverse adjustment allows ability to level wall quickly
- Allows flexibility of use of 6 male options depending on panel weight and size (2kg - 15kg pull out load)
- Remove and refit panels in any sequence time after time

APPLICATIONS

- Stone/ concrete/ brick walls
- Drywall/ plasterboard
- Interior refurbishment of existing block wall
- Applying acoustic panels to block wall
- Applying various panel types to concrete or drywall

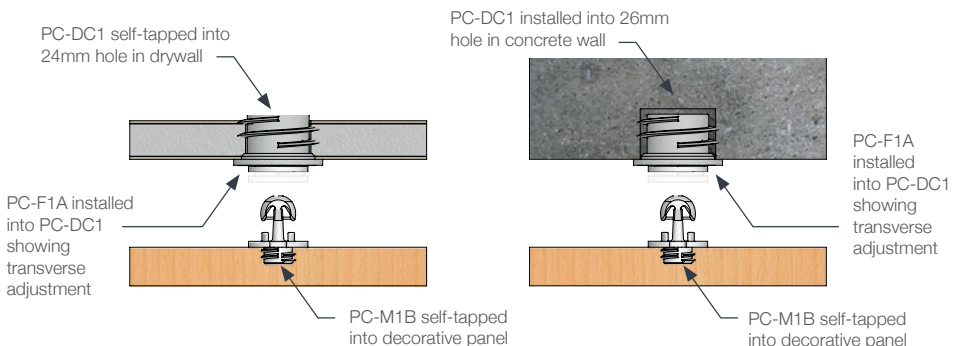
INSTALLATION: Partially exploded through section showing typical installation method

Total control.



The perfect solution for removable acoustic panels.













The PC-SM1AC is your solution for removable acoustic panels. Typical acoustic panel installation methods can be unreliable, time consuming and have inconsistent results. Strong enough to hold a lightweight panel, but soft enough to remove the panel without kinking the material, using the flexible PC-SM1AC ensures that neither your panel nor wall is damaged upon removal.



Panel mounting solution:
PC-SM1AC - acoustic panel
PC-F1A - substrate

STANDARD PC RANGE

PC-F1A Self Tapping Female

PC-F1A 	USE WITH:				INSTALL WITH:			
	PC-M1B 	PC-VM1 	PC-M2H 	PC-VMX 	CT-01 	CT-07 	CT-03 	CT-10 
	PC-SM2 	PC-SVMX 	PC-SM2H 	PC-SM1AC 				

INSTALLATION STEPS FOR UPHOLSTERED PANELS

1 Drill hole through panel and frame

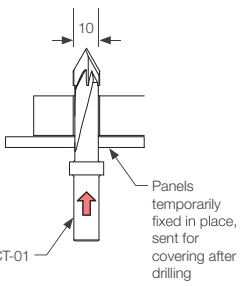

10

CT-01

Panels temporarily fixed in place, sent for covering after drilling

2 Drill out frame hole with CT-07

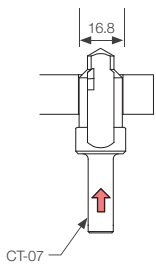

16.8

CT-07

3 Screw fit PC-F1A with CT-03. Use battery drill with clutch set.

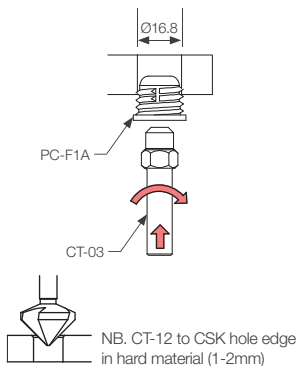

16.8

PC-F1A

CT-03

NB. CT-12 to CSK hole edge in hard material (1-2mm)

4 Screw fit PC-F1A into thin frame

PC-F1A can be used as screw / friction fit into thin frames and seat backs

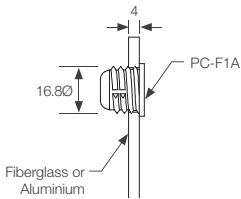

4

16.8Ø

PC-F1A

Fiberglass or Aluminium

NB. CT-12 to CSK hole edge in hard material (1-2mm)

5 Cutaway view showing panel mounting

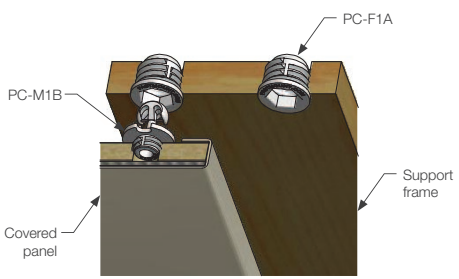













PC-F1A

PC-M1B

Covered panel

Support frame

PC-F1A Self Tapping Female

PC-F1A 	USE WITH:				INSTALL WITH:			
	PC-M1B 	PC-VM1 	PC-M2H 	PC-VMX 	CP-01ST 	CT-09 	CT-07 	CT-10 
	PC-SM2 	PC-SVMX 	PC-SM2H 	PC-SM1AC 				

INSTALLATION STEPS FOR PAINTED OR PREFINISHED PANELS (First complete steps 1 to 3, page 1)

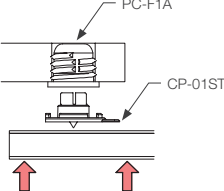
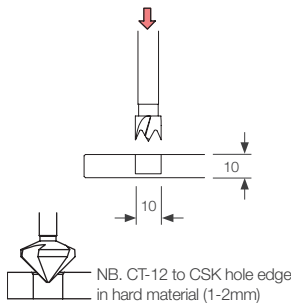
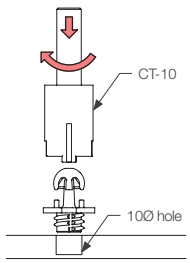
<p>1 Fit CP-01ST into PC-F1A then push panel to mark center</p> 	<p>2 Drill panel on center mark with CT-09 6mm deep for PC-M1B, 8mm deep for PC-VM1, PC-VMX, PC-M2H</p>  <p>NB. CT-12 to CSK hole edge in hard material (1-2mm)</p>	<p>3 Screw fit male clip with CT-10. Use battery drill with clutch set.</p> 
--	--	--

INSTALLING ADHESIVE FIT MALE CLIPS (FIRST COMPLETE STEPS 1 TO 3, PAGE 1)

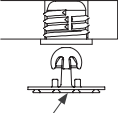
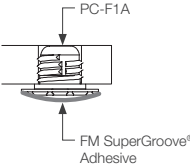
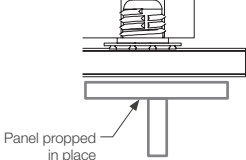
<p>4 Clip PC-SM2 into PC-F1A</p>  <p>PC-SM2 or PC-SM2H</p>	<p>5 Apply adhesive to PC-SM2</p>  <p>FM SuperGroove® Adhesive</p>	<p>5 Place panel and support while adhesive dries</p>  <p>Panel propped in place</p>
--	--	--

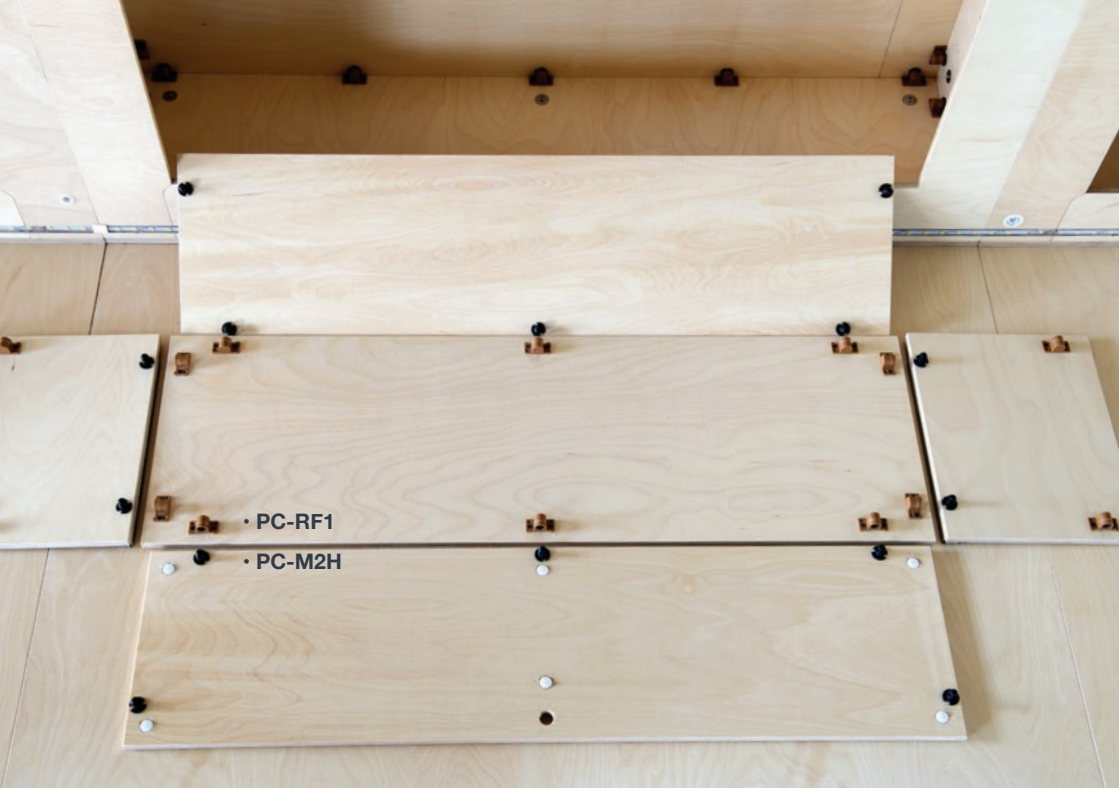

• PC-RF1

• PC-M2H



Panel mounting solution:

PC-RF1 internal











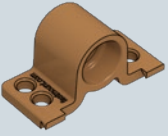

PC-M2H internal

STANDARD PC RANGE



INSTALLATION GUIDE

PC-RF1 Side Mount Female

PC-RF1 	USE WITH:				INSTALL WITH:			
	PC-M1B	PC-VM1	PC-M2H	PC-VMX	CP-01ST	CT-09	CT-10	CT-18DG
	      	   						

INSTALLATION STEPS

- 1** Screw fit PC-RF1 to side of frame

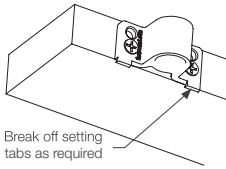

- 2** Fit CP-01ST into PC-RF1

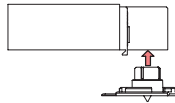

- 3** Press panel onto CP-01ST to mark

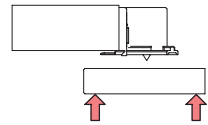

- 4** Drill panel on mark with CT-09

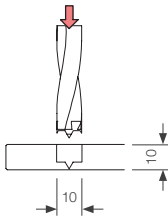

- 5** Screw fit male clip with CT-10

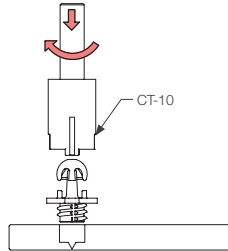

- 6** Panel clipped in place

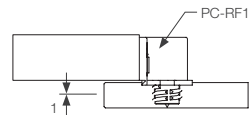

OPTION WITH ADHESIVE FIT MALE (COMPLETE STEP ABOVE)

- A** Clip PC-SM2 into PC-RF1

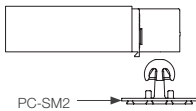

- B** Apply adhesive to PC-SM2



- C** Place panel and support while adhesive dries

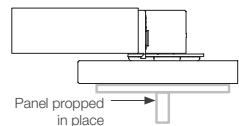

MORE INFO: Clip Layout Guide TD-02

STANDARD PC RANGE

PC-SF1 Surface Mount Female

	USE WITH:				INSTALL WITH:		
	PC-M1B 	PC-VM1 	PC-M2H 	PC-VMX 	CP-01ST 	CT-09 	CT-10 
	PC-SM2 	PC-SVMX 	PC-SM2H 	PC-SM1AC 			

INSTALLATION STEPS

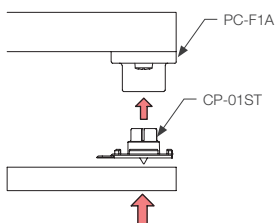
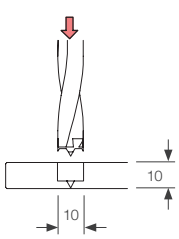
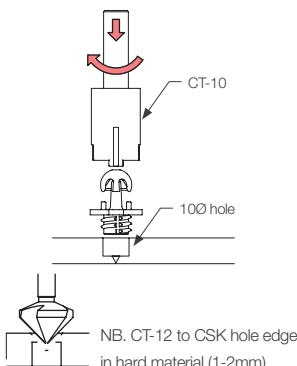



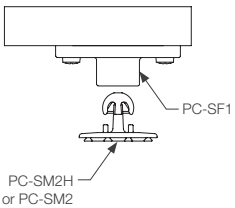
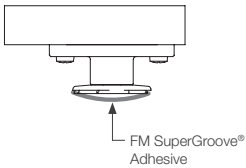
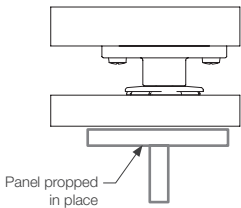



















<p>1 Fit CP-01ST into PC-SF1 then push panel to mark center</p> 	<p>2 Drill panel on center mark with CT-09 7.5mm deep</p> 	<p>3 Screw fit male clip with CT-10. Use battery drill with clutch set.</p> 
---	--	--

INSTALLING ADHESIVE FIT MALE CLIPS (FIRST COMPLETE STEPS 1, PAGE 1)

<p>4 Clip PC-SM2 into PC-SF1</p> 	<p>5 Apply adhesive to PC-SM2</p> 	<p>6 Place panel and support while adhesive dries</p> 
--	--	--

MORE INFO: Clip Layout Guide TD-02

PC-SF1 Surface Mount Female

PC-SF1	USE WITH:	INSTALL WITH:																
	<table border="0"> <tr> <td data-bbox="340 437 412 453">PC-M1B</td> <td data-bbox="421 437 481 453">PC-VM1</td> <td data-bbox="493 437 554 453">PC-M2H</td> <td data-bbox="566 437 627 453">PC-VMX</td> </tr> <tr> <td data-bbox="348 464 395 507"></td> <td data-bbox="421 464 468 507"></td> <td data-bbox="505 464 552 507"></td> <td data-bbox="577 464 624 507"></td> </tr> <tr> <td data-bbox="340 518 400 534">PC-SM2</td> <td data-bbox="421 518 481 534">PC-SVMX</td> <td data-bbox="493 518 554 534">PC-SM2H</td> <td data-bbox="566 518 627 534">PC-SM1AC</td> </tr> <tr> <td data-bbox="348 545 395 588"></td> <td data-bbox="421 545 468 588"></td> <td data-bbox="505 545 552 588"></td> <td data-bbox="577 545 624 588"></td> </tr> </table>	PC-M1B	PC-VM1	PC-M2H	PC-VMX					PC-SM2	PC-SVMX	PC-SM2H	PC-SM1AC					Screw or rivet
PC-M1B	PC-VM1	PC-M2H	PC-VMX															
																		
PC-SM2	PC-SVMX	PC-SM2H	PC-SM1AC															
																		

INSTALLATION STEP OPTIONS

1 Screw fix PC-SF1 to frame

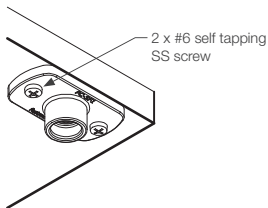

2 Options for mounting PC-SF1 to support frame

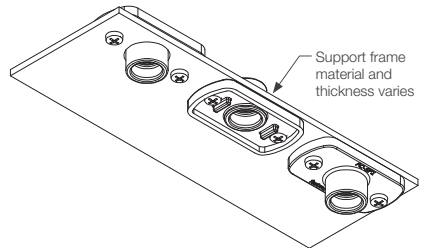



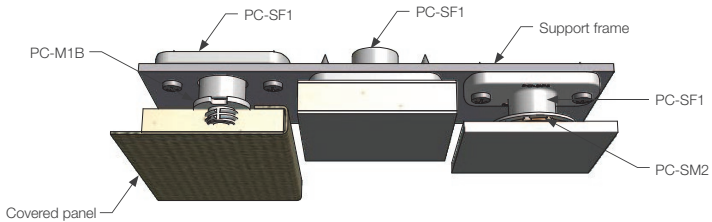

























3 Options for mounting PC-SF1 to support frame and male clip and panel types



STANDARD PC RANGE







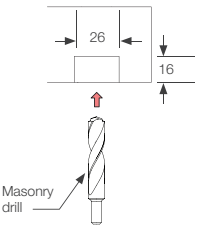
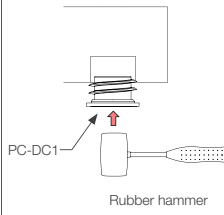
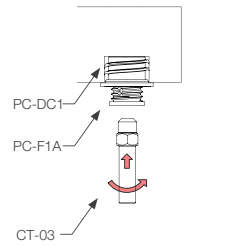
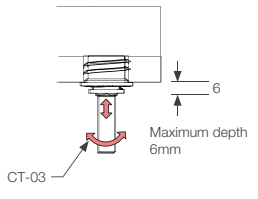
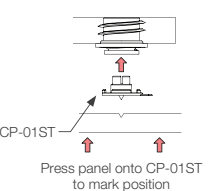
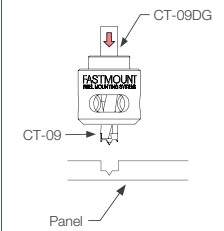
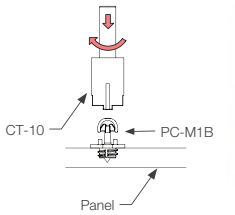
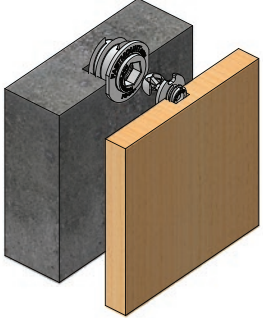

























PC-DC1 Female Anchor - Concrete

PC-DC1	USE WITH:	INSTALL WITH:												
	<table border="0"> <tr> <td data-bbox="246 438 319 518">PC-F1A </td> <td data-bbox="330 438 403 518">PC-M1B </td> <td data-bbox="414 438 487 518">PC-VM1 </td> <td data-bbox="498 438 571 518">PC-SM2 </td> </tr> <tr> <td data-bbox="246 518 319 598">PC-M2H </td> <td data-bbox="330 518 403 598">PC-VMX </td> <td data-bbox="414 518 487 598">PC-SVMX </td> <td data-bbox="498 518 571 598">PC-SM2H </td> </tr> <tr> <td colspan="4" data-bbox="582 518 666 598">PC-SM1AC </td> </tr> </table>	PC-F1A 	PC-M1B 	PC-VM1 	PC-SM2 	PC-M2H 	PC-VMX 	PC-SVMX 	PC-SM2H 	PC-SM1AC 				<p>26mm masonry drill Rubber hammer</p> <p>CP-01ST CT-03 CT-09 CT-09DG</p> 
PC-F1A 	PC-M1B 	PC-VM1 	PC-SM2 											
PC-M2H 	PC-VMX 	PC-SVMX 	PC-SM2H 											
PC-SM1AC 														

INSTALLATION STEPS FOR CONCRETE

<p>1 Drill 26mm hole, 16mm deep</p>  <p>Masonry drill</p>	<p>2 Hammer-set flush</p>  <p>PC-DC1 Rubber hammer</p>	<p>3 Screw PC-F1A into PC-DC1</p>  <p>PC-DC1 PC-F1A CT-03</p>	<p>4 Adjust depth to suit</p>  <p>6 Maximum depth 6mm CT-03</p>
<p>5 Fit CP-01ST into PC-F1A</p>  <p>CP-01ST Press panel onto CP-01ST to mark position</p>	<p>6 Drill out mark on panel with CT-09</p>  <p>CT-09DG CT-09 Panel</p>	<p>7 Screw fit male clip with CT-10</p>  <p>CT-10 PC-M1B Panel</p>	 <p>Cross section of PC-DC1, PC-F1A & PC-M1B installed</p>

PC-DC1 Female Anchor - Drywall





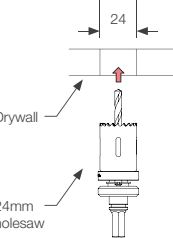
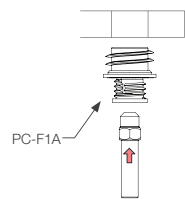
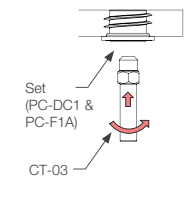
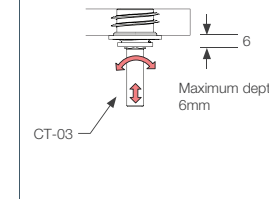
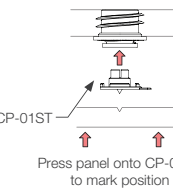
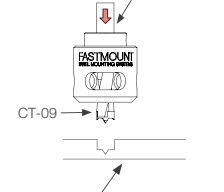
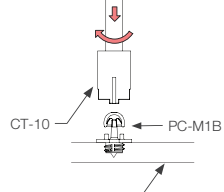
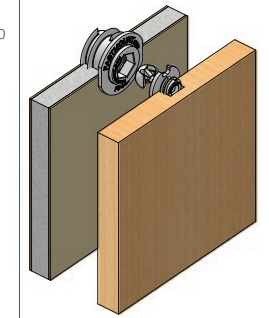





PC-DC1 	USE WITH:	INSTALL WITH:												
	<table border="0"> <tr> <td>PC-F1A </td> <td>PC-M1B </td> <td>PC-VM1 </td> <td>PC-SM2 </td> </tr> <tr> <td>PC-M2H </td> <td>PC-VMX </td> <td>PC-SVMX </td> <td>PC-SM2H </td> </tr> <tr> <td></td> <td></td> <td></td> <td>PC-SM1AC </td> </tr> </table>	PC-F1A 	PC-M1B 	PC-VM1 	PC-SM2 	PC-M2H 	PC-VMX 	PC-SVMX 	PC-SM2H 				PC-SM1AC 	24mm holesaw CP-01ST  CT-03  CT-09  CT-09DG 
PC-F1A 	PC-M1B 	PC-VM1 	PC-SM2 											
PC-M2H 	PC-VMX 	PC-SVMX 	PC-SM2H 											
			PC-SM1AC 											

INSTALLATION STEPS FOR DRYWALL

<p>1 Drill 24mm hole into drywall</p>  <p>Drywall 24mm holesaw</p>	<p>2 Screw PC-F1A into PC-DC1 using CT-03</p>  <p>PC-F1A</p>	<p>3 Screw set into drywall using low clutch setting and speed</p>  <p>Set (PC-DC1 & PC-F1A) CT-03</p>	<p>4 Adjust depth to suit</p>  <p>6 Maximum depth 6mm CT-03</p>
<p>5 Fit CP-01ST into PC-F1A</p>  <p>CP-01ST Press panel onto CP-01ST to mark position</p>	<p>6 Drill out mark on panel with CT-09</p>  <p>CT-09DG CT-09 Panel</p>	<p>7 Screw fit male clip with CT-10</p>  <p>CT-10 PC-M1B Panel</p>	 <p>Cross section of PC-DC1, PC-F1A & PC-M1B installed</p>

STANDARD PC RANGE

PC-SVMX Surface Mount Male Screw Fix - 15kg

PC-SVMX	USE WITH:	INSTALL WITH:
	<p>PC-F1A </p> <p>PC-SF1 PC-RF1 PC-AF1   </p>	<p>3 x #6 screw CT-13A CT-03 CT-05 CT-05H</p>     

INSTALLATION STEPS

- 1 Drill CT-13A through frame or substrate

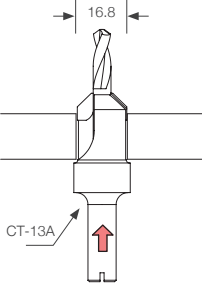

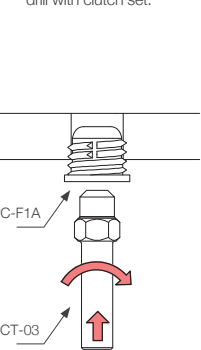
- 2 Screw fit PC-F1A with CT-03. Use battery drill with clutch set.

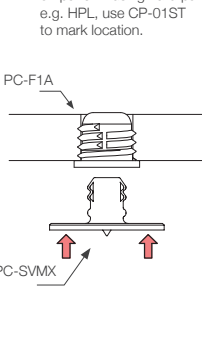

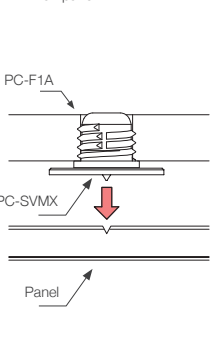
- 3 Clip PC-SVMX into PC-F1A to mark male clip location on panel. If using hard panels e.g. HPL, use CP-01ST to mark location.

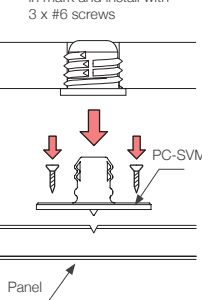
- 4 Press panel onto PC-SVMX to mark male clip position on panel.

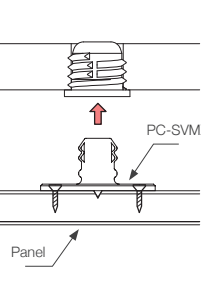
- 5 Un-clip PC-SVMX from PC-F1A using CT-05, position PC-SVMX in mark and install with 3 x #6 screws

- 6 Clip panel into place.

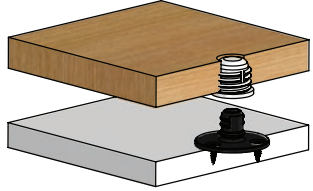



Extra heavy duty
mounting, made simple.



Panel mounting solution:
PC-F1A - substrate
PC-SVMX - panel

LOW PROFILE LP RANGE

LP-F8 Low Profile Self Tapping Female



SPECIFICATIONS:

The LP-F8 self-tapping female is designed for fitting into substrates with min. 9mm thickness. Compatible with all female clips in the Low Profile Range (pull out load determined by male clip used. Refer to Panel Offset Guide for gap between substrate and panel, pull out and shear loads.

LOW PROFILE LP RANGE

BENEFITS

- Hidden fixing
- Self taps into substrates from 9mm thick
- Perfect panel alignment and secure mounting every time
- Remove and refit panels in any sequence multiple times
- 5kg or 15kg pull out load per clip
- Allows for flexing and expansion of panel and support frame

APPLICATIONS

- Suitable for covered, painted and prefinished panels
- Suitable for carbon/ foam core substrates
- Refits and upgrades of existing installations
- Bedheads, artwork
- Composites and thin-walled panels

LP-F8



USE WITH:

LP-M8A



LP-SM8AS



LP-SMX



MATERIAL:

White acetal copolymer

MORE INFO:

Installation Guide LP-F8
Clip Layout Guide TD-02, TD-08
Panel Offset Guide

INSTALLATION: Partially exploded through section showing typical installation method

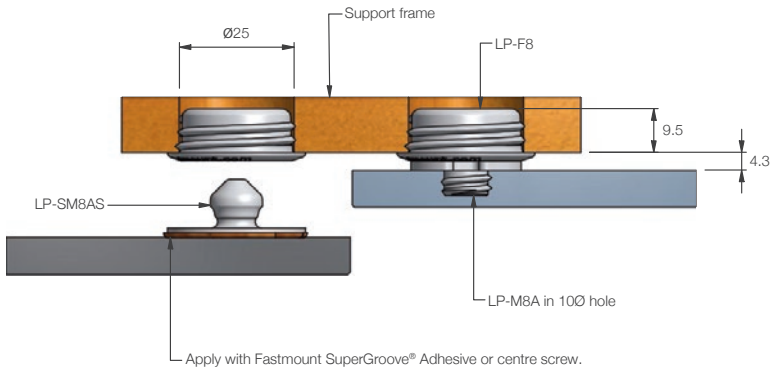



PRODUCT SHEET

LP-AF8A Low Profile Autofit Female



SPECIFICATIONS:

LOW PROFILE LP RANGE

The LP-AF8A female clip provides 360 degree lateral adjustment, fitting into a 35ø hole. The LP-AF8A mounts into a variety of substrates, and is compatible with all male clips in the Low Profile Range. Refer to Panel Offset Guide for gap between substrate and panel, pull out and shear loads.

LP-AF8A



USE WITH:

LP-M8A

LP-SM8AS



LP-SMX



MATERIAL:

White acetal copolymer

MORE INFO:

Layout Guide TD-02, TD-08
Panel Offset Guide

BENEFITS

- Hidden fixing with 8mm lateral adjustment
- Screw or glue into plywood min. 9mm thick
- Perfect panel alignment and secure mounting every time
- Remove and refit panels in any order multiple times
- 5kg or 15kg pull out load per clip
- Allows for flexing and expansion of panel and support frame

APPLICATIONS

- Covered or painted and prefinished panels
- Curved panels
- Refits and upgrades of existing installations
- Where installation tolerance is required
- Can be moulded into fibreglass
- Moulded into hull

INSTALLATION: Partially exploded through section showing typical installation method

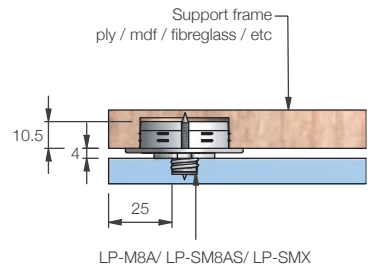
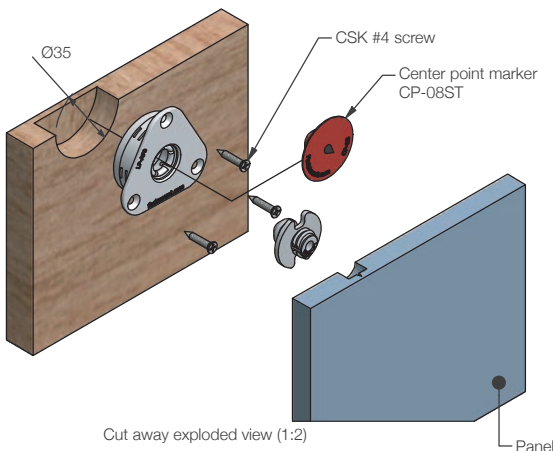

Typical section (1:2)

LOW PROFILE LP RANGE

LP-DF8 Tapping Coarse Thread Female



SPECIFICATIONS:

The LP-DF8 is specifically designed for soft core material such as drywall. A wide thread self-taps securely into plasterboard (drywall). Compatible with LP-M8A and LP-SM8AS. Not for use with LP-SMX due to high pull out load. Refer to Panel Offset Guide for gap between substrate and panel, pull out and shear loads.

LP-DF8



MATERIAL:
White acetal copolymer

USE WITH:



MORE INFO:
Installation Guide LP-DF8
Clip Layout Guide TD-02, TD-08
Panel Offset Guide

LOW PROFILE LP RANGE

BENEFITS

- Hidden fixing
- Self taps into drywall plasterboard min. 10mm thick
- Perfect panel alignment with secure mounting every time
- Remove and refit panels in any sequence multiple times
- 5kg pull out load per clip
- Allows for flexing and expansion of panel

APPLICATIONS

- Covered or painted and prefinished panels
- Acoustic panels
- Refits and upgrades of existing installations
- Bed heads, artwork

INSTALLATION: Partially exploded through section showing typical installation method

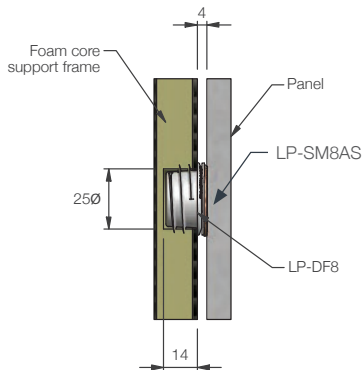
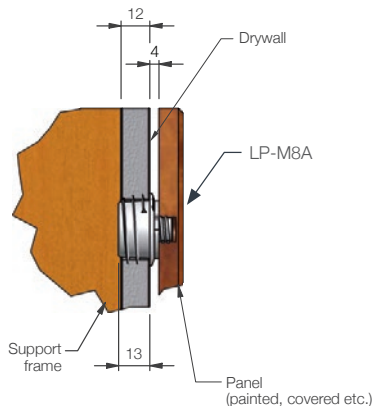

LP-M8A Self Tapping Male - 5kg**SPECIFICATIONS:****LOW PROFILE LP RANGE**

The LP-M8A is a male low profile self-tapping clip designed to mount easily into plywood and MDF panels. Compatible with the LP-F8, LP-DF8 and LP-AF8A, the LP-M8A allows mounting of panels into a variety of substrate types, including plasterboard. Refer to Panel Offset Guide for gap between substrate and panel, pull out and shear loads.

BENEFITS

- Invisible fixing to enhance panel appearance
- Self taps into plywood or MDF with minimum 6 mm thickness
- 5kg pull out load per clip set
- Remove and replace panels in any sequence 500+ times
- 4mm clearance between panel and substrate
- CNC machine compatibility
- Acoustic isolation

APPLICATIONS

- Wall panels
- Lightweight ceiling panels
- Covered, painted and prefinished panels
- Interior panels
- Bedheads, artwork

LP-M8A**USE WITH:**

LP-F8



LP-DF8



LP-AF8A

**MATERIAL:**

White acetal copolymer

MORE INFO:

Layout Guide TD-02, TD-08
Panel Offset Guide

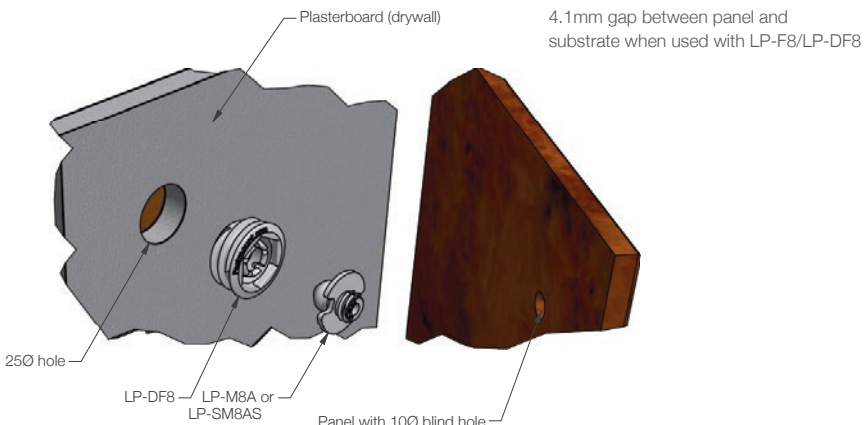
INSTALLATION: Partially exploded through section showing typical installation method

LOW PROFILE LP RANGE

LP-SM8AS Surface Mount Male Adhesive Fix - 5kg



SPECIFICATIONS:

The LP-SM8AS is a male low profile clip with a surface mount installation. Featuring Fastmount's patented SuperGroove base, the grooves mechanically engage into the Fastmount SuperGroove Adhesive to create a bond that supports a 5kg pull out load. Ideal for thin panels or panels where drilling into the surface is not possible. The clip also offers an option to screw fix directly through the head for rapid installation. Mounts into LP-F8, LP-DF8 and LP-AF8A female clips. Refer to Panel Offset Guide for gap between substrate and panel, pull out and shear loads.

LOW PROFILE LP RANGE

BENEFITS

- No special tools required for installation
- Adhesive or screw fix
- 5kg pull out load
- 4.3mm clearance between panel and substrate
- CNC machine compatibility
- Acoustic isolation

APPLICATIONS

- Thin wall panels
- Lightweight ceiling panels
- Covered, painted or prefinished panels
- Interior panels
- Refit and upgrade work

LP-SM8AS



USE WITH:

LP-F8



LP-DF8



LP-AF8A



MATERIAL:

White acetal copolymer

MORE INFO:

Installation Guide LP-F8
Clip Layout Guide TD-02, TD-08
Panel Offset Guide

INSTALLATION: Partially exploded through section showing typical installation method

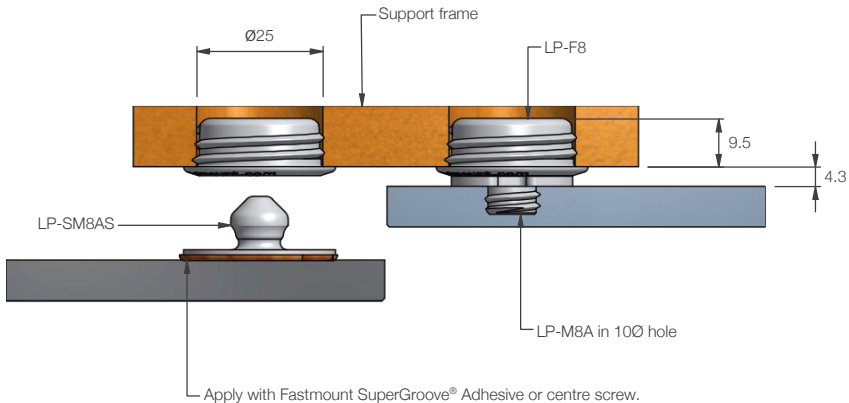

LP-SMX Surface Mount Male Screw Fix – 15kg**SPECIFICATIONS:****LOW PROFILE LP RANGE**

The LP-SMX clip adds an extra heavy-duty option to the Low Profile Range. With a 15kg pull out load, the clip is designed for use with heavyweight panels, and is compatible with the LP-F8, and LP-AF8A. The surface mount clip installs easily with 3 x countersink #6 screws, removing the need for special tools for installation. Ideal for large and heavyweight panels with limited panel depth. **NOTE:** Should not be used with LP-DF8 installing into drywall substrate, due to strength of the clip. Refer to Panel Offset Guide for gap between substrate and panel, pull out and shear loads.

BENEFITS

- Invisible panel fixing
- Installs with 3 x #6 countersink screws
- No special tools required
- 15kg pull out load per clip
- Durable design for frequent handling
- Enables non-sequential panel installation
- CNC machine compatibility
- 4mm clearance between panel and substrate
- Screw fix enables installation into wide variety of panel types

APPLICATIONS

- Heavyweight wall panels with minimal depth
- Interior panels
- Ceiling panels
- Moulded into hull
- Marine and architectural applications
- Steel, aluminium or fiberglass panels

**MATERIAL:**

Black glass filled nylon

USE WITH:

LP-F8





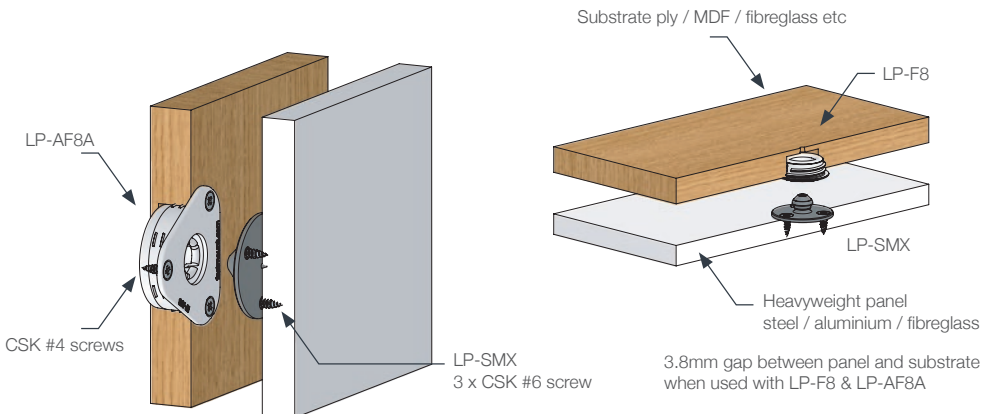

LP-AF8A

**MORE INFO:**Layout Guide TD-02, TD-08
Panel Offset Guide**INSTALLATION:** Partially exploded through section showing typical installation method

LOW PROFILE LP RANGE

LP-F8 Low Profile Surface Mount Female

LP-F8	USE WITH:	INSTALL WITH:	
	LP-SM8AS	25Ø drill	CT-19
			

INSTALLATION STEPS Using LP-SM8AS - adhesive fix option

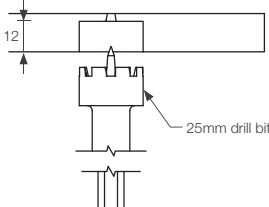
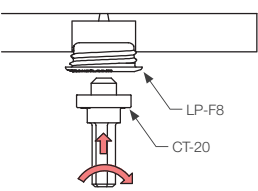
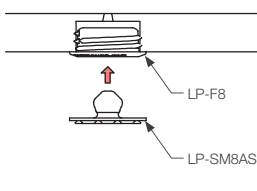
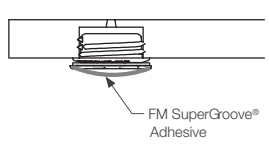
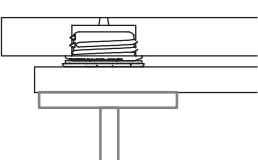



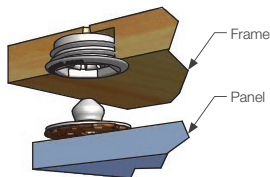

<p>1 Drill 25Ø hole in frame</p>  <p>12</p> <p>25mm drill bit</p>	<p>2 Screw LP-F8 into frame, use battery drill with clutch set.</p>  <p>LP-F8</p> <p>CT-20</p>	<p>3 Fit LP-SM8AS into LP-F8</p>  <p>LP-F8</p> <p>LP-SM8AS</p>
<p>4 Adhesive to LP-SM8AS</p>  <p>FM SuperGroove® Adhesive</p>	<p>5 Drill panel on mark with CT-09</p>  <p>Place panel in position, and support while adhesive dries</p>	

A Cutaway view of installed clip (panel removed)



MORE INFO: Clip Layout guide TD-02 & TD-08

LP-F8 Low Profile Self Tapping Female

LP-F8	USE WITH:	INSTALL WITH:				
	LP-M8A	CP-08ST	25Ø drill	CT-19	CT-09	CT-10
						

INSTALLATION STEPS Using LP-M8A - self tapping option

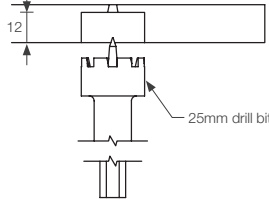
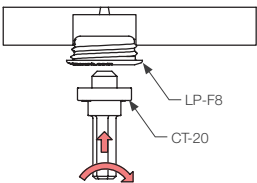
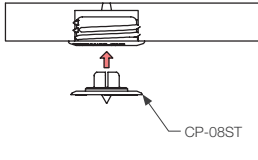
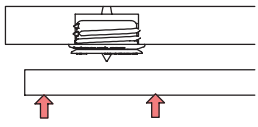
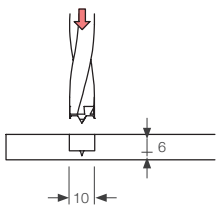
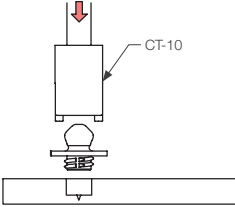
<p>1 Drill 25Ø hole in frame</p> 	<p>2 Screw LP-F8 into frame. Use battery drill with clutch set.</p> 	<p>3 Fit CP-08ST centre point into LP-F8</p> 
<p>4 Press panel onto CP-08ST to mark</p> 	<p>5 Drill panel on mark with CT-09</p> 	<p>6 Screw fit LP-M8A with CT-10. Use battery drill with clutch set.</p> 

A Cutaway view of installed clip

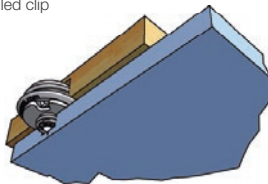



NB. CT-12 to CSK hole edge in hard material (1-2mm)

MORE INFO: Clip Layout guide TD-02 & TD-08



LOW PROFILE LP RANGE

INSTALLATION GUIDE

LP-DF8 Low Profile Drywall Self Tapping Coarse Thread Female

<p>LP-DF8</p> 	<p>USE WITH:</p>	<p>INSTALL WITH:</p>
	<p>LP-M8A LP-SM8AS</p> 	<p>CP-08ST 25Ø hole saw CT-19 CT-09 CT-10</p> 

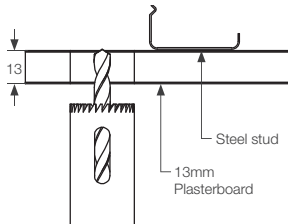
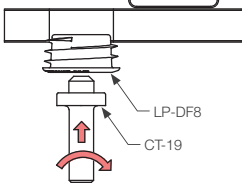
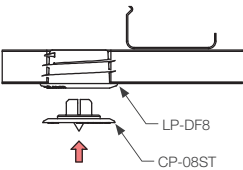
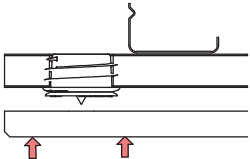
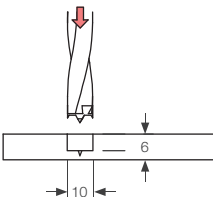
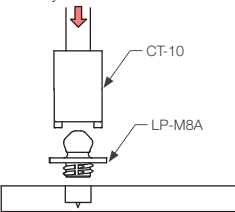
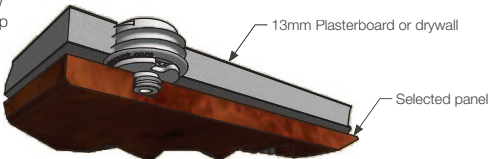
INSTALLATION STEPS Using LP-M8A - self tapping option. See LP-SM8AS for adhesive fix option

<p>1 Drill 25Ø hole in drywall plasterboard</p> 	<p>2 Screw LP-DF8 into drywall. Use battery drill with clutch set, fit only once, do not over tighten</p> 	<p>3 Fit CP-08ST centre point into LP-DF8</p> 
<p>4 Press panel onto CP-08ST to mark</p> 	<p>5 Drill panel on mark with CT-09</p> 	<p>6 Screw fit LP-M8A with CT-10. use battery drill with clutch set.</p> 
<p>A Cutaway view of installed clip</p> 		 <p>NB. CT-12 to CSK hole edge in hard material (1-2mm)</p>

Change
panels
whenever
you want.



ASB Bank, New Zealand





• LP-DF8 + LP-SM8AS

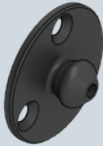

Panel mounting solution:
LP-DF8 - drywall
LP-SM8AS - panel

LOW PROFILE LP RANGE

LP-SMX Surface Mount Male Screw Fix – 15kg

LP-SMX	USE WITH:	INSTALL WITH:
	LP-F8 LP-AF8A  	 3 x #6 countersink screws For installation into LP-F8, follow steps 1-4 on LP-F8 install guide.

INSTALLATION STEPS

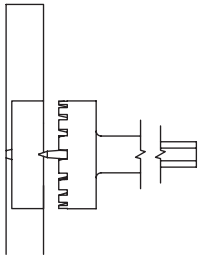
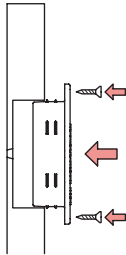
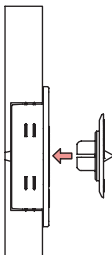
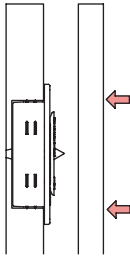
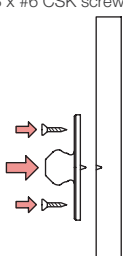
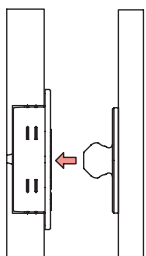
<p>1 Drill out 350 hole in substrate</p> 	<p>2 Press LP-AF8A into drilled hole, fix with 3x #4 CSK screw</p> 	<p>3 Fit CP-08ST into LP-AF8A</p> 
<p>4 Press panel onto CP-08ST to mark clip position</p> 	<p>5 Locate LP-SMX into marked position on panel, install with 3 x #6 CSK screws</p> 	<p>6 Align panel and press firmly to engage clips</p> 

Low profile,
high strength.



Panel mounting solution:

LP-AF8A - substrate

LP-SMX - panel

VERY LOW PROFILE VL RANGE

VL-03 & VL-03H Very Low Profile Clip Set



SPECIFICATIONS:

The VL-03 and VL-03H are ideal for mounting ceiling and wall panels in areas with minimal frame and panel thickness. The VL-03 and VL-03H clip sets use the patented SuperGroove® system to mechanically engage into adhesive. Screw or adhesive combinations can be used. Refer to Panel Offset Guide for gap between substrate and panel, pull out and shear loads.

VERY LOW PROFILE VL RANGE

BENEFITS

- Self-aligning secure mounting
- Installation requires no special tools or skilled labour
- Uses a range of adhesives to suit the customer
- Fast installation
- 5kg or 10kg pull out load
- Clip lead in for easy fitting
- Can be screw fixed with lateral adjustment, or glue fixed

APPLICATIONS

- Areas with minimal clearance
- Inspection panels
- Soft or honeycomb cored panels with thin facings
- Mounting panels where no drilling is preferred

VL-03 5kg

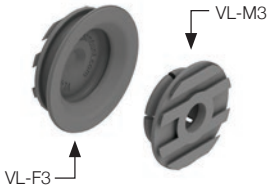

VL-03H 10kg

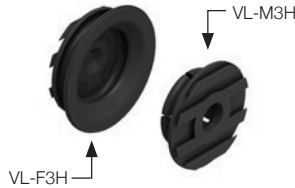

MATERIAL:

Grey or black acetal / nylon GF

MORE INFO:

Installation Guide VL-03
Clip Layout Guide TD-02, 08, 09
Panel Offset Guide

INSTALLATION: Partially exploded through section showing typical installation method

Through section showing recessed installation

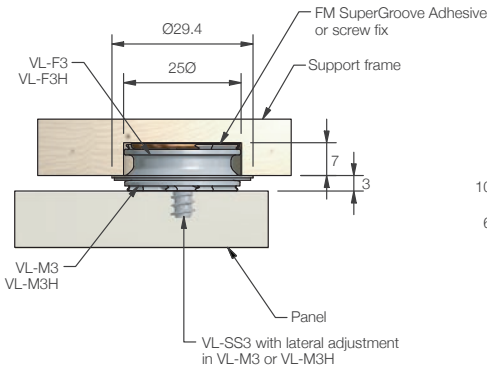

Through section showing surface mounted adhesive installation

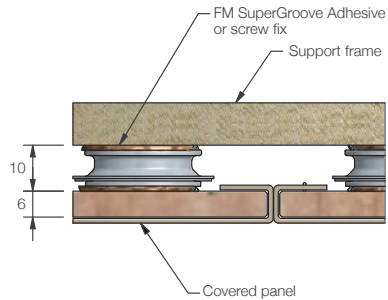



PRODUCT SHEET

VL-03FR Very Low Profile Clip Set Fire Rated



SPECIFICATIONS:

The VL-03FR combines the Very Low Profile convenience for ceiling and wall panels, with a fire rating, making it useful in commercial areas where fire rating is required on thin panels. The VL-03FR can be rivet or screw fixed. Incorporates the patented SuperGroove® system. Tested to out-perform external screw fixings in fire rating testing using fire rated MDF with B Euroclass by CSTB*.

*Scientific and Technical Centre for Building, France. Refer to Panel Offset Guide for gap between substrate and panel, pull out and shear loads.

VL-03FR 10kg



MATERIAL:
PBT

MORE INFO:
Installation Guide VL-03
Clip Layout Guide TD-02, 08, 09

VERY LOW PROFILE VL RANGE

BENEFITS

- Fire rated plastic with V-0 UL rating
- GWIT test at 2mm: 625°C, test method IEC-60695-2-13
- 10kg pull out load
- Rivet or screw fix to steel frames
- Screw fix to panels to ensure mechanical connection
- No special installation tools required

APPLICATIONS

- Fire rated ceiling and wall panels in areas with minimal frame and panel thickness
- Inspection panels
- Thin panels

INSTALLATION: Partially exploded through section showing typical installation method

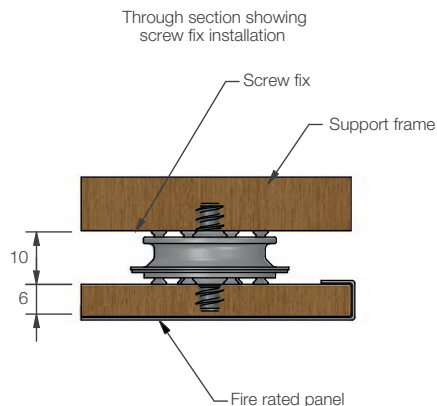

VERY LOW PROFILE VL RANGE

INSTALLATION GUIDE

VL-03, VL-03H & VL-03 FR Very Low Profile Clip Set

VL-03 5kg	VL-03H 10kg	VL-03FR 10kg	USE WITH:	INSTALL WITH:
			VL-SS3	VL-CP3
			Fastmount SuperGroove® Adhesive	

INSTALLATION STEPS

- 1** Exploded view of typical installation (adhesive fix)

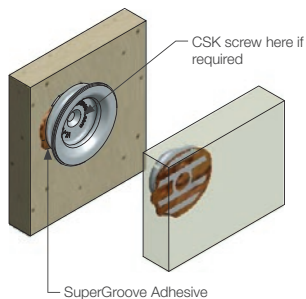

- 2** Section through installed clip

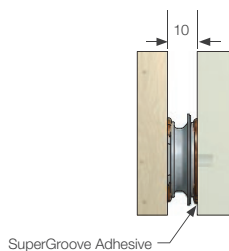

- 3** Exploded view showing centre point marker, install option

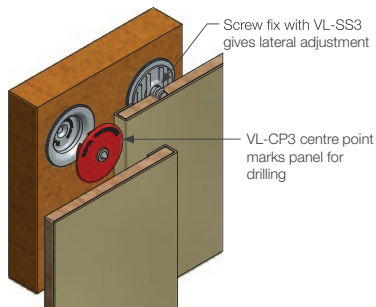

- 4** Section through recessed installation

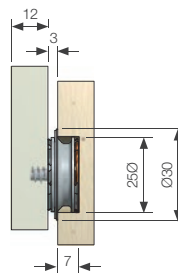

MORE INFO: Clip Layout Guide TD-02 Product sheet VL-03

Confidence
that just clicks.

As the size of high-scale superyachts and commercial buildings increase, so do the number of regulations for building materials. Which is why Fastmount has designed the fire rated version of the VL-03 clip set. Perfect for corridors or egress areas, the VL-03FR can squeeze into the smallest of spaces with a rivet or screw fix, as Fastmount's lowest-profile, fastest installing clip set.



Panel mounting solution:

VL-M3FR - panel
VL-F3FR - substrate
VL-SS3 - screw fix

Tested to out-perform external screw fixings in fire rating testing using fire rated MDF with B Euroclass by CSTB*.

*Scientific and Technical Centre for Building, France.

METAL MC RANGE

MC-05 Metal Clip Set MC-F5 & MC-M5 - 5kg



SPECIFICATIONS:

METAL MC RANGE

The MC-05 clip set is a combination of the MC-F5 (identified by white centre) and MC-M5 clips. The MC-F5 self taps and/or screw fixes into the substrate, and the MC-M5 self taps into the back of the panel. Innately fire resistant and ideal for heavy load bearing. Refer to Panel Offset Guide for gap between substrate and panel, pull out and shear loads.

BENEFITS

- Metal clip to withstand high temperatures
- Allows for tolerance and panel flex (self centering)
- Provides acoustic and vibration isolation
- 5kg pull out load
- Self tapping and screw fit mounting options

APPLICATIONS

- Fire rated panels
- Panels in fire egress paths
- Ceiling, wall and exterior panels
- Mounting of curved panels
- Variety of substrates

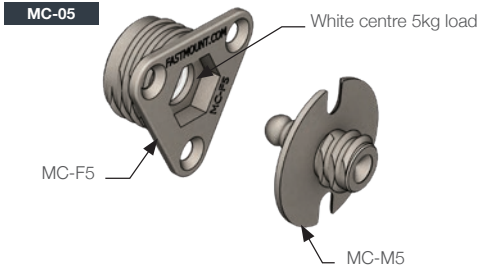

MATERIAL:
EZDA 3 triple plated, SS spring

MORE INFO:
Installation Guide MC-05
Clip Layout Guide TD-02, 09, 12
Panel Offset Guide

INSTALLATION: Partially exploded through section showing typical installation method

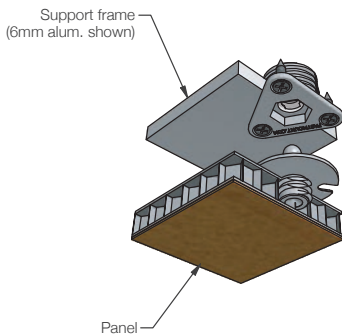

Cutaway exploded view (nts)

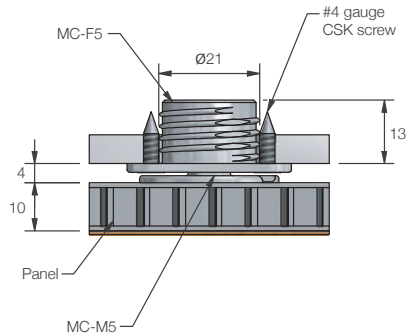

Typical section (1:1)

Heavy-duty,
with fire-resistance.

• MC-M5 + MC-F5



Panel mounting solution:
MC-M5 - floor panel
MC-F5 - substrate

METAL MC RANGE

MC-10 Metal Clip Set MC-F10 & MC-M5 - 10kg



SPECIFICATIONS:

METAL MC RANGE

The MC-10 clip set is a combination of the MC-F10 (identified by black centre) and MC-M5 clips. The MC-F10 self taps and/or screw fixes into the substrate, and the MC-M5 self taps into the back of the panel. Innately fire resistant and ideal for heavy load bearing. Refer to Panel Offset Guide for gap between substrate and panel, pull out and shear loads.

BENEFITS

- Metal clip to withstand high temperatures
- Allows for tolerance and panel flex (self centering)
- Provides acoustic and vibration isolation
- 10kg pull out load
- Self tapping and screw fit mounting options

APPLICATIONS

- Suitable for mounting up to 40kg per m²
- Fire rated panels
- Panels in fire egress paths
- Ceiling, wall and exterior panels
- Mounting of curved panels
- Install into a variety of substrates

MC-10

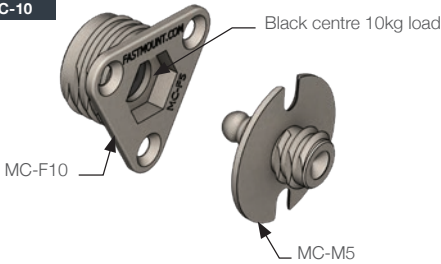

MATERIAL:

EZDA 3 triple plated, SS spring

MORE INFO:

Installation Guide MC-05
Clip Layout Guide TD-02, 09, 12
Panel Offset Guide

INSTALLATION: Partially exploded through section showing typical installation method

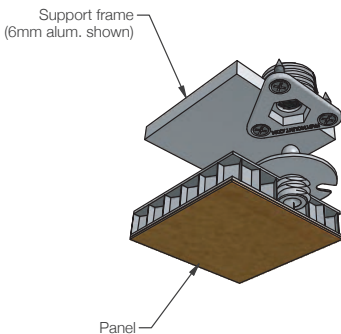

Cutaway exploded view (nts)

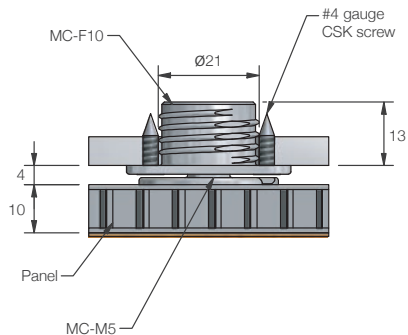

Typical section (1:1)

MC-SM5 Metal Male Clip – Surface Mount

MC-SM5-VHBFR Metal Male Clip – Adhesive Mount Fire Rated

SPECIFICATIONS:



METAL MC RANGE

The Fastmount Metal Range was designed for demanding applications that require fire resistance and heavy load bearing. The surface mount male provides a rapid install fixing compatible with the MC-F5 (5kg pull-out load) and MC-F10 (10kg pull-out load), with the option to screw or rivet fix to the panel using the MC-SM5, or self-adhesive fix using the MC-SM5-VHBFR. The MC-SM5-VHBFR is supplied with fire-rated VHB adhesive backing pre-applied for rapid panel mounting. Gap between panel and substrate with MC-SM5: 3.75mm; with MC-SM5-VHBFR: 4.75mm. Refer to Panel Offset Guide for gap between substrate and panel, pull out and shear loads.

BENEFITS

- Stainless steel clip withstands high temperatures
- MC-SM5-VHBFR supplied with fire-resistant tape attached
- Simple install with rivet, screw (MC-SM5) or adhesive (MC-SM5-VHBFR)
- 5kg pull out load with MC-F5
- 10kg pull out load with MC-F10

APPLICATIONS

- Marine, architectural, aviation and RV
- Interior panels
- Aluminium honeycomb panels
- Lightweight fire rated panels
- Fire-rated heavyweight panels
- High density panels, where surface mount is required
- Interior FR alucobond panels
- Fire rated access panels



MATERIAL:

306 Stainless Steel

MORE INFO:

Installation Guide MC-SM5
Panel Offset Guide

INSTALLATION: Partially exploded through section showing typical installation method

Cutaway exploded view (nts)

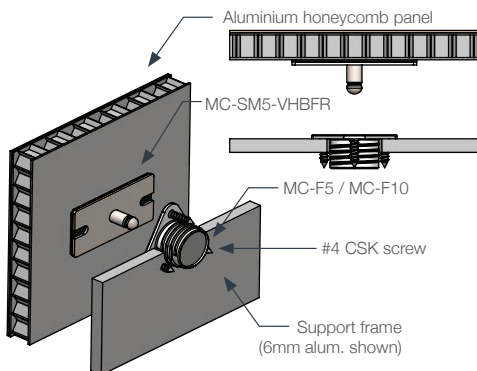

For installation into LP-F8, follow steps 1-4 on LP-F8 install guide.

Cutaway exploded view (nts)

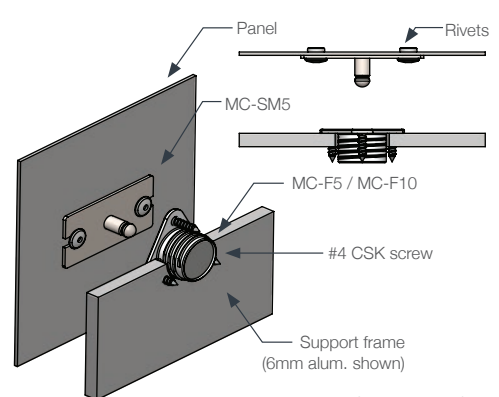

3.75mm gap between panel and substrate with MC-SM5

METAL MC RANGE

MC-05 & MC-10 Metal Clip Set

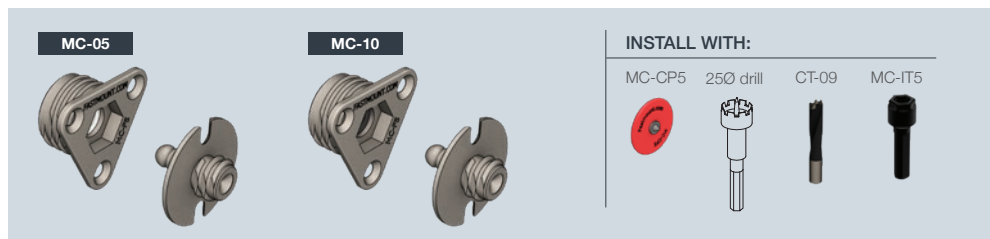

INSTALLATION STEPS Self tapping method

- 1** Drill hole through support frame and fit MC-F5 or MC-F10

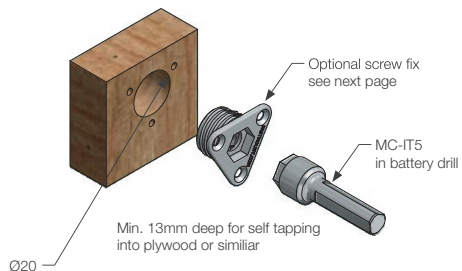

- 2** Mark panel with MC-CP5

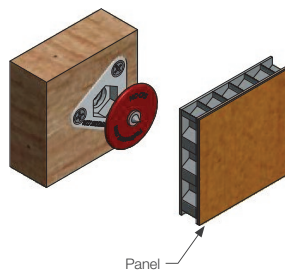

- 3** Drill panel on centre mark

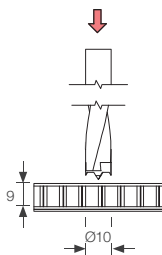

- 4** Self tapping screw fit MC-M5 into panel

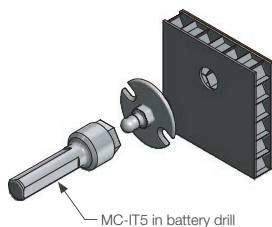

- 5** Exploded cutaway view of installed clip set

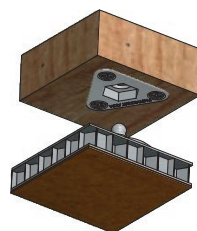

MC-05 & MC-10 Maxi Metal Clip Set

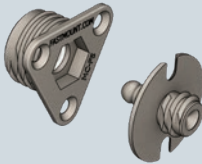
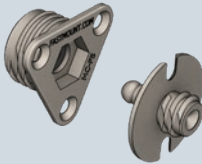
MC-05	MC-10	USE WITH:	INSTALL WITH:
		#4 gauge CSK screw	MC-CP5 25Ø drill CT-09 MC-IT5

INSTALLATION STEPS Screw fix method

- 1 Drill clearance hole through support frame and fit MC-F5 or MC-F10

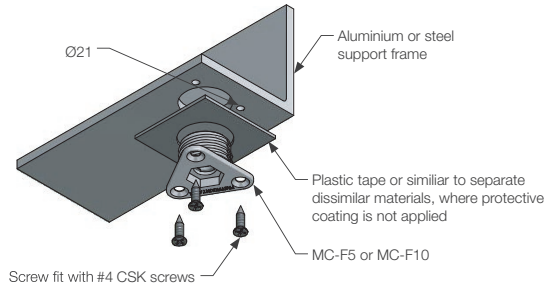

- 2 MC-M5 screw fixed to panel

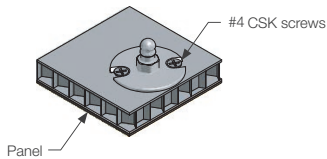

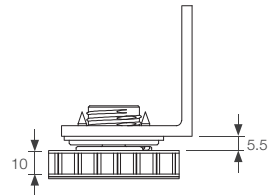

- 3 Cutaway section showing metal frame



Check for separation of dissimilar metals when using MC-05 or MC-10 with aluminium or similar, in exterior applications.

METAL MC RANGE

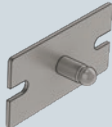
MC-SM5 Metal Male Clip – Surface Mount

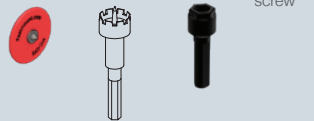

<p>MC-SM5</p> 	<p>USE WITH:</p> <p>MC-F5 MC-F10</p> 	<p>INSTALL WITH:</p> <p>MC-CP5 20Ø drill MC-IT5 #4 CSK screw</p> 
---	--	--

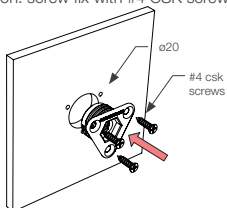
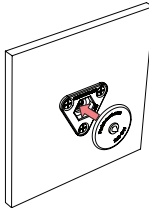
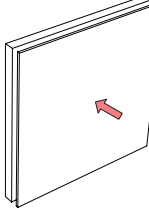
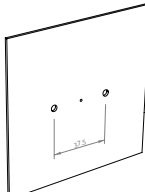
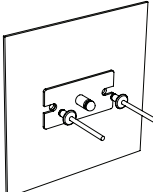
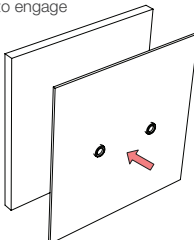
INSTALLATION STEPS MC-SM5 to MC-F5

<p>1 Drill hole into support frame, fit MC-F5 or MC-F10 with MC-IT5 tool. Option: screw fix with #4 CSK screws</p>  <p>Note: min. 13mm deep for self-tapping into plywood or similar</p>	<p>2 Insert MC-CP5 into female clip to mark panel location</p> 	<p>3 Press panel firmly in position to mark correct MC-SM5 location</p> 
<p>4 Drill holes for screw or rivet fixing. Holes should be a minimum 19mm away from mark</p> 	<p>5 Position MC-SM5 and screw or rivet fix to panel</p> 	<p>6 Press panel against substrate to engage</p> 

MORE INFO: SETOUT GUIDE TD-02, 09, 12. PRODUCT SHEET MC-05

MC-SM5-VHBFR Metal Male Clip – Adhesive Mount Fire Rated

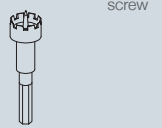
<p>MC-SM5-VHBFR</p> 	<p>USE WITH:</p> <p>MC-F5 MC-F10</p> 	<p>INSTALL WITH:</p> <p>22Ø drill #4 CSK screw</p> 
--	--	--

INSTALLATION STEPS MC-SM5-VHBFR to MC-F5

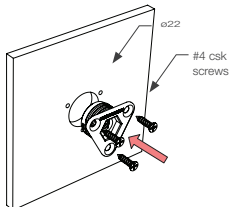
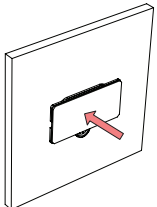
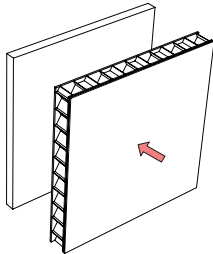
<p>1 Drill hole into support frame, fit MC-F5 or MC-F10 with MC-IT5 tool. Option: screw fix with #4 CSK screws</p> 	<p>2 Clip MC-SM5-VHB into female clip, and remove protective backing from adhesive</p> 	<p>3 Align panel into correct position and press firmly against substrate to fix.</p> 
---	---	---

COMING SOON

STRATLOCK SL RANGE

STRATLOCK RAIL SYSTEM
BY FASTMOUNT

SL-FA Stratlock® Female Side Mount Clip

SL-FA-FR Stratlock® Female Side Mount Clip - Fire Rated



SPECIFICATIONS:

STRATLOCK SL RANGE

The SL-FA provides rapid installation of heavy panels into side-channel aluminium extrusion framework. Designed specifically for contract interior fit out applications, the SL-FA / SL-FA-FR is also suitable for superyacht deckhead panels. Female installs rapidly with a twist-lock function into the side channel, and can be screwed or riveted into its final position. Used with the SL-M10/SL-M18 /SL-M18-FR, the new solid internal load chassis creates 4mm supported movement of the panel in any direction at the first engagement before locking into place with a 10/18kg pull out load. Patent Pending.

Designed for the new Stratlock Rail System by Fastmount, or fits into groove dimensions: mouth: 7.5mm - 8.5mm, depth: min 7mm, wall thickness: 0.75mm - 1.2mm. The distance between the panel and substrate when installed is 12.5mm at the first click, and 6mm when pressed into final position.

BENEFITS

- Strongest mounting available
- T-lock function for rapid installation into channel with screw or pop rivet
- Supported movement of the panel 4mm in any direction before locking into final position.
- No special tools required for installation
- Acoustic isolation between panel and frame
- Designed for aluminium extrusion
- Option of 10kg or 18kg pull out load with SL-M10 or SL-M18
- 6mm standoff between frame and panel
- Adjustability along channel for easy spacing - no drilling required
- SL-FA-FR available in V-0 rated FR Nylon

APPLICATIONS

- Commercial interior fit out
- Architectural and marine applications
- Mounting heavier ceiling and wall panels
- Hotels, hospitals, retail
- Residential fitout
- Superyacht deckhead panels
- Fire-rated interiors

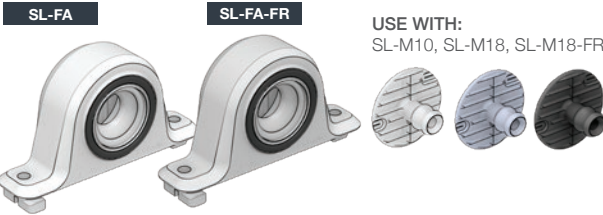

MATERIAL:

White acetyl, rubber o-ring
FR Nylon, rubber o-ring

MORE INFO:

Installation Guide SL-FA
Clip Layout Guide TD-15, 17

INSTALLATION: Partially exploded through section showing typical installation method

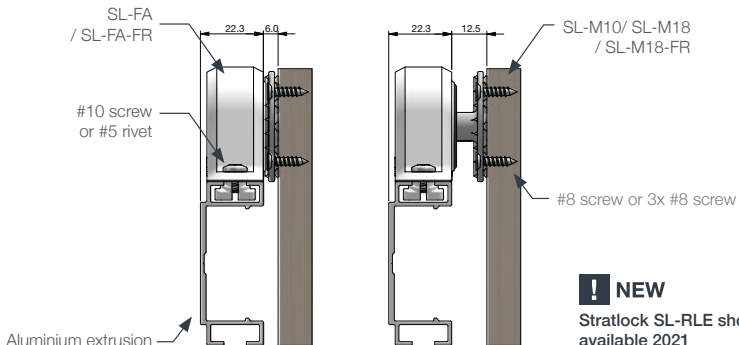

NEW

Stratlock SL-RLE shown,
available 2021

SL-FB Stratlock® Female Front Mount**SL-FB-FR** Stratlock® Female Front Mount - Fire Rated**SPECIFICATIONS:**

The SL-FB provides rapid installation of heavy panels into 18mm standard galvanized steel rail framework. Designed specifically for contract interior fit out applications. Female installs rapidly with a push fit function into the steel channel, and does not require fastenings. Used with the SL-M10/SL-M18 / SL-M18-FR, the new solid internal load chassis creates 4mm supported movement of the panel in any direction at the first engagement before locking into place with an 10/18kg pull out load. Patent Pending.

Designed for the new Stratlock Rail System by Fastmount, or fits into channel dimensions: mouth: 35.0mm - 35.75mm, depth: min 15.75mm - 16.5mm, wall thickness: N/A. The distance between the panel and substrate when installed is 12.5mm at the first click, and 6mm when pressed into final position.

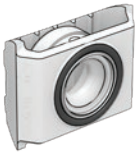
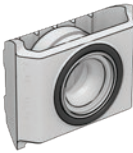
SL-FB**SL-FB-FR****USE WITH:**

SL-M10, SL-M18, SL-M18-FR

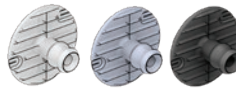
**MATERIAL:**

White acetyl, rubber o-ring
FR PBT, rubber o-ring

MORE INFO:

Installation Guide SL-FB
Clip Layout Guide TD-16, 18
Panel Offset Guide

**STRATLOCK SL RANGE****BENEFITS**

- Strongest mounting available
- Supported movement of the panel 4mm in any direction before locking into final position.
- Push fit into rail face
- No special tools required
- Acoustic isolation between panel and frame
- Fits into front channel steel extrusion
- Option of 10kg or 18kg pull out load with SL-M10 or SL-M18
- Adjustability along channel for easy spacing - no drilling required
- SL-FB-FR available in V-0 rated FR PBT

APPLICATIONS

- Commercial interior fit out
- Mounting heavier ceiling and wall panels
- Architectural applications
- Hotels, hospitals, retail, residential
- Fire-rated wall panels

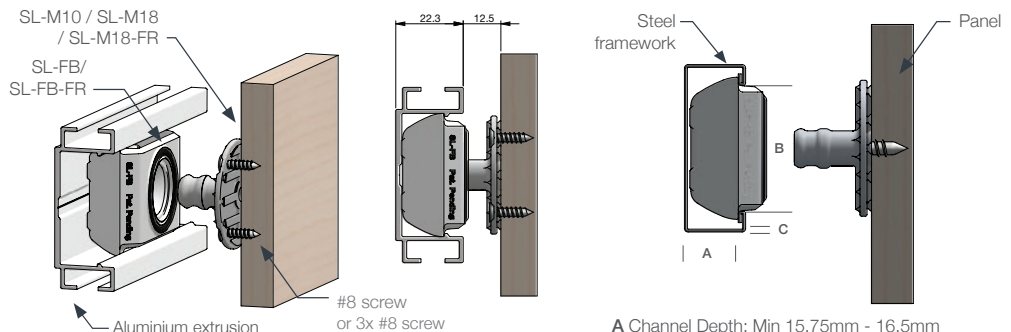
INSTALLATION: Partially exploded through section showing typical installation method

! **NEW** Stratlock SL-RLE shown, available 2021

A Channel Depth: Min 15.75mm - 16.5mm

B Channel Mouth: 35.0mm - 35.75mm

C (Channel Wall Thickness: Wall thickness does not effect clip)

STRATLOCK SL RANGE

SL-SFA Stratlock® Female Side Mount – For Timber
SL-SFA-FR Stratlock® Female Side Mount - Fire Rated
SPECIFICATIONS:



STRATLOCK SL RANGE

The SL-SFA provides rapid installation of heavy panels to timber, steel or aluminium framework. Designed specifically for contract interior fitout applications to reduce onsite installation time. Female installs onto side of framework with 2 x #8 panhead screws (20mm) in timber frames, and #8 tek screws (20mm) into steel or aluminium framework. Used with the SL-M10/SL-M18 / SL-M18-FR the new solid internal load chassis creates 4mm supported movement of the panel in any direction at the first engagement before locking into place with an 10/18kg pull out load. The distance between the panel and substrate when installed is 12.5mm at the first click, and 6mm when pressed into final position. Patent Pending.

BENEFITS

- Strongest mounting available
- Side mount with rapid screw fixing
- Supported movement of the panel 4mm in any direction before locking into final position.
- No special tools required for installation
- Acoustic isolation between panel and frame
- Option of 10kg or 18kg pull out load with SL-M10 or SL-M18
- 6mm clearance between panel and frame
- SL-SFA-FR available in V-0 rated FR nylon

APPLICATIONS

- Commercial interior fitout
- Residential interior fitout
- Architectural applications
- Mounting heavy wall panels
- Fire rated interior panels

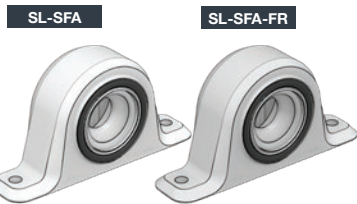

USE WITH:
 SL-M10, SL-M18, SL-M18-FR



MATERIAL:
 White acetyl, rubber o-ring
 FR Nylon, rubber o-ring

MORE INFO:
 Installation Guide SL-SFA
 Clip Layout Guide TD-15, 17

INSTALLATION: Partially exploded through section showing typical installation method

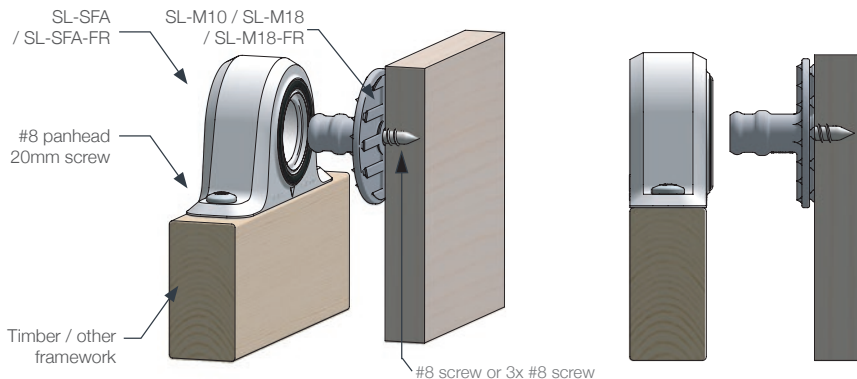

SL-FC Stratlock® Female Flush Mount**SL-FC-FR** Stratlock® Female Flush Mount - Fire Rated**SPECIFICATIONS:**

The SL-FC / SL-FC-FR provides rapid installation of heavy panels to solid substrates. Designed specifically for contract interior fitout applications to reduce onsite installation time. The SL-FC is ideal for applications where framework or grid structure is not available (e.g. sheet metal, aluminium, fibreglass, MDF or plywood). SL-FC fits into a pre-drilled ø40mm hole, and screw fixes with 3 x #5 screws. The Patent Pending internal load chassis of the female clip creates 4mm supported movement of the panel in any direction before locking into place with a 10 or 18kg pull out load, depending on the male clip used (SL-M10 or SL-M18). Distance between panel and substrate when installed is 13.5mm at first click, and 7mm when pressed into final position. Patent Pending. Refer to Panel Offset Guide for gap between substrate and panel, pull out and shear loads.

SL-FC

**NEW !**

SL-FC-FR

**NEW !****USE WITH:**

SL-M10, SL-M18, SL-M18-FR

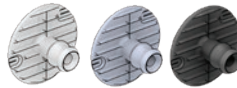
**MORE INFO:**

Installation Guide SL-FC
Clip Layout Guide TD-19, 20
Panel Offset Guide

MATERIAL:

White acetyl, rubber o-ring
FR PBT, rubber o-ring

INSTALLATION: Partially exploded through section showing typical installation method

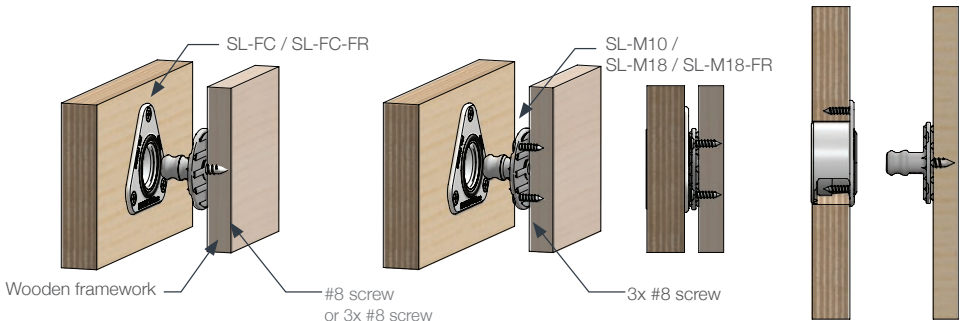
**BENEFITS**

- Strongest available fixing from Fastmount
- Flush fit for solid substrates
- Supported movement of the panel 4mm in any direction before locking into final position
- No special tools required for installation
- Acoustic isolation between panel and frame
- Option of 10kg or 18kg pull out load with SL-M10 or SL-M18
- 7mm clearance between panel and frame

APPLICATIONS

- Commercial interior fitout
- Residential interior fitout
- Architectural applications
- Mounting heavy wall panels
- Aluminium, sheet steel, fibreglass, plywood or MDF substrates

**STRATLOCK SL RANGE**

COMING SOON

STRATLOCK SL RANGE

STRATLOCK RAIL SYSTEM
BY FASTMOUNT

SL-M10 Stratlock® Male 10kg

SPECIFICATIONS:

The male SL-M10 attaches to the panel, and mounts into either SL-FA, SL-SFA, SL-FB or SL-FC for rapid mounting of heavy panels to aluminium or steel extrusion framework, or solid substrates. The SL-M10 has a lower pull out load of 10kg for more frequently removed panels still requiring strength and high shear loading. Featuring a unique two-stage engagement head, the SL-M10 engages into the new solid internal load chassis to give 4mm supported movement in any direction before locking into place. Option to fix into panel using 1 x #8 screw, 3 x #8 screws or adhesive fix with Fastmount SuperGroove® Adhesive. No special tools required for installation. Patent Pending. Refer to Panel Offset Guide for gap between substrate and panel, pull out and shear loads.

STRATLOCK SL RANGE

BENEFITS

- 10kg pull out load
- Supported movement of the panel 4mm in any direction before locking into final position.
- Option to screw fix with 1 x #8, or 3 x #8 screws
- Option to adhesive fix with Fastmount SuperGroove® Adhesive
- No special tools required for install
- Acoustic isolation between panel and frame
- Fits into SL-FA, SL-SFA, SL-FB or SL-FC

APPLICATIONS

- Commercial interior fit out
- Mounting ceiling and wall panels
- Hotels, hospitals, retail, residential
- Superyacht deckheads

SL-M10 10kg**NEW !**

MATERIAL:
White nylon

USE WITH:

SL-FA
SL-SFA
SL-FB
SL-FC



MORE INFO:

Installation Guide SL-FA,
SL-SFA, SL-FB, SL-FC
Clip Layout Guide TD-15
Panel Offset Guide

INSTALLATION: Partially exploded through section showing typical installation method

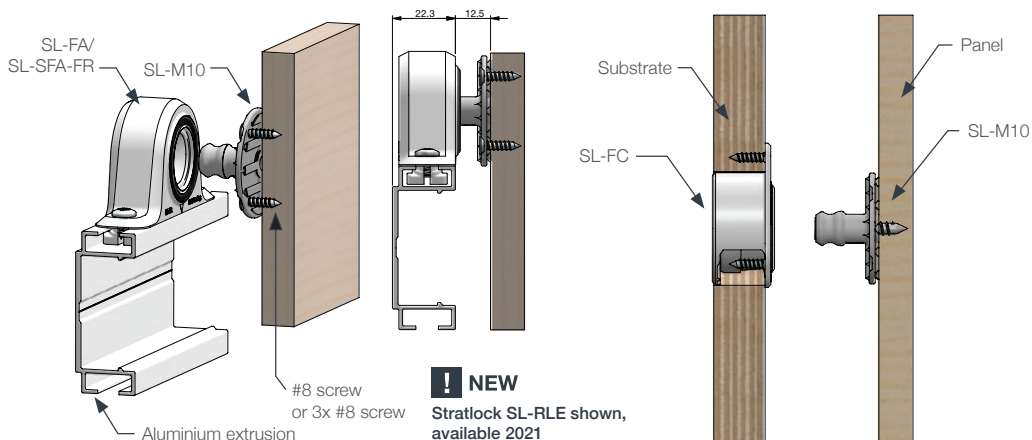

SL-M18 Stratlock® Male 18kg
SL-M18-FR Stratlock® Male 18kg - Fire Rated



STRATLOCK SL RANGE

SPECIFICATIONS:

The SL-M18 attaches to the panel, and mounts into either SL-FA, SL-SFA, SL-FB or SL-FC for rapid mounting of heavy panels to aluminium or steel extrusion framework. The SL-M18-FR/ SL-M18-FR can be combined with fire-rated female clips from the Stratlock Range where fire-resistance is required. Featuring a two-stage engagement head, the SL-M18 engages into the new solid internal load chassis to give 4mm supported movement in any direction before locking into place. Option to fix into panel with 1 or 3 #8 screws or Fastmount SuperGroove Adhesive. Combined with any female clip from the Stratlock Range, the SL-M10/SL-M18 / SL-M18-FR has an 10/18kg pull out load and high shear strength. Patent Pending. Refer to Panel Offset Guide for gap between substrate and panel, pull out and shear loads.

SL-M18 18kg **SL-M18-FR** 18kg

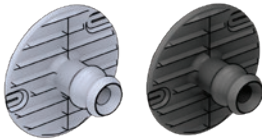

NEW ! **NEW !**

MATERIAL:

Off white glass-filled nylon
 Black Shinite

USE WITH:

SL-FA / SL-FA-FR
 SL-SFA / SL-SFA-FR
 SL-FB / SL-FB-FR
 SL-FC / SL-FC-FR

MORE INFO:

Installation Guide SL-FA,
 SL-SFA, SL-FB, SL-FC
 Clip Layout Guide TD-15
 Panel Offset Guide



BENEFITS

- Strongest mounting available
- Supported movement of the panel 4mm in any direction before locking into final position.
- Screw fix with 1 or 3 #8 screws, or Fastmount SuperGroove Adhesive or SuperGroove Adhesive fix
- No special tools required
- Acoustic isolation between panel and frame
- Fits into SL-FA / SL-FA-FR, SL-SFA / SL-SFA-FR, SL-FB / SL-FB-FR and SL-FC / SL-FC-FR
- 18kg pull out load & high shear strength

APPLICATIONS

- Commercial interior fit out
- Mounting heavier ceiling and wall panels
- Hotels, hospitals, retail, residential
- Superyacht deckheads
- Fire-rated interiors

INSTALLATION: Partially exploded through section showing typical installation method

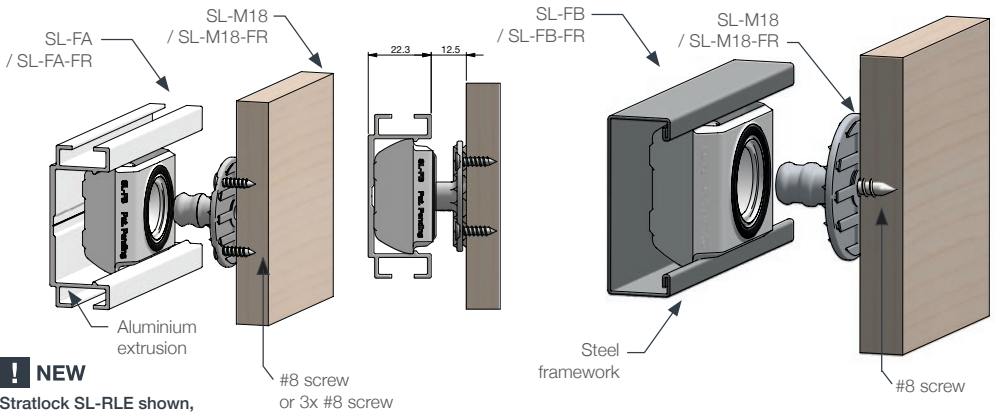

! NEW
 Stratlock SL-RLE shown,
 available 2021



Steel rail or
aluminium extrusion?

We're setting the
standard for panel
mounting with those too.

Coming soon is the Stratlock® Rail System by Fastmount, a complete answer to aluminium extrusions, connectors and panel fasteners, built with the Fastmount finish.

Use the QR code to sign up for updates or go to
https://fastmount.com/en/faqs/product_subscription



Patented 4mm adjust & lock
positioning function.

! COMING SOON

STRATLOCK RAIL SYSTEM
BY FASTMOUNT

! COMING SOON

STRATLOCK RAIL SYSTEM
BY FASTMOUNT



Setting the standard for panel mounting

SL

STRATLOCK SL RANGE

SL-FA Stratlock® Range - Screw Fix

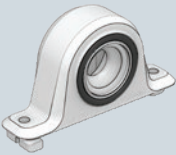
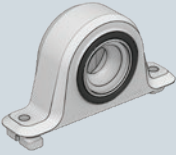
SL-FA-FR Stratlock® Range - Screw Fix - Fire Rated

SL-FA	SL-FA-FR	USE WITH:	INSTALL WITH:
		SL-M10, SL-M18, SL-M18-FR 	#5 screws #8 screws #10 screws CP-01ST 

INSTALLATION STEPS

 Screw-fix method - follow same steps for fire-rated Stratlock clips

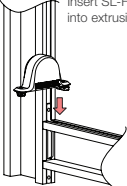
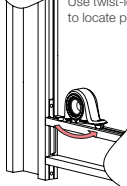
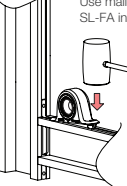
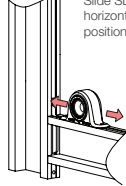
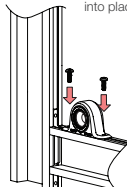
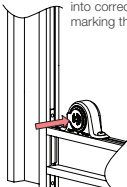
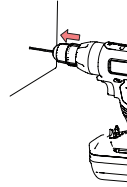
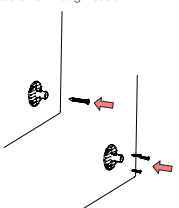
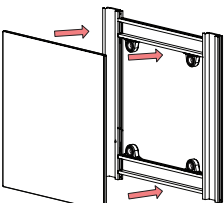
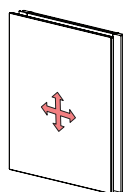
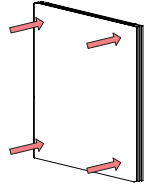
<p>1 Insert SL-FA into extrusion frame</p> 	<p>2 Use twist-lock function to locate position</p> 	<p>3 Use mallet to press SL-FA into frame</p> 	<p>4 Slide SL-FA horizontally into final position if required</p> 
<p>5 Use 2 x #10 screws or #5 rivets to fix into place</p> 	<p>6 Insert CP-01 ST into SL-FA and press panel into correct position, marking the panel</p> 	<p>7 Drill out mark created by CP-01 ST with 3mm drill bit</p> 	<p>8 Install SL-M18 with 1 x #8 screw through centre or 3 x #5 screws through base</p> 
<p>9 Engage panel to first click of SL-M18 into SL-FA</p> 	<p>10 Adjust panel to find correct position</p> 	<p>11 Once panel is in correct location, engage second click by pressing panel into final position.</p> 	<p>! NEW Stratlock SL-RLE shown, available 2021</p>

COMING SOON

STRATLOCK SL RANGE

STRATLOCK RAIL SYSTEM
BY FASTMOUNT

SL-FA Stratlock® Range - Adhesive Fix

<p>SL-FA</p> 	<p>USE WITH:</p> <p>SL-M10, SL-M18</p> 	<p>INSTALL WITH:</p> <p>Fastmount SuperGroove® Adhesive</p> <p>#10 screws</p>
--	---	--

INSTALLATION STEPS Adhesive fix method

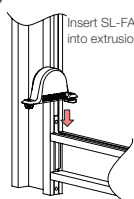
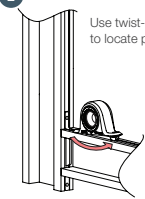
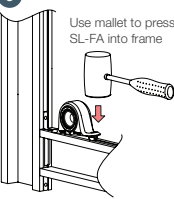
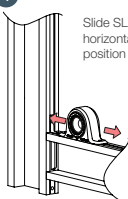
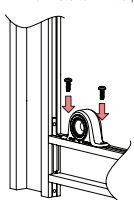
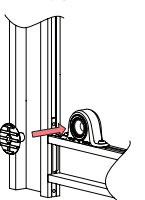
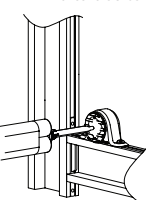
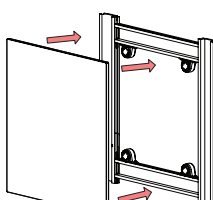
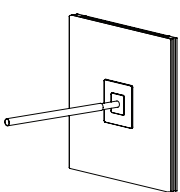
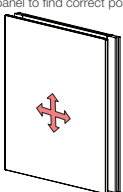
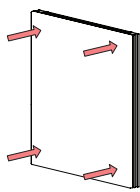
<p>1</p>  <p>Insert SL-FA into extrusion frame</p>	<p>2</p>  <p>Use twist-lock function to locate position</p>	<p>3</p>  <p>Use mallet to press SL-FA into frame</p>	<p>4</p>  <p>Slide SL-FA horizontally into final position if required</p>
<p>5</p>  <p>Use 2 x #10 screws or #5 rivets to fix into place</p>	<p>6</p>  <p>Engage SL-M18 two clicks into SL-FA</p>	<p>7</p>  <p>Apply Fastmount SuperGroove® Adhesive CG-5010 to SL-M18</p>	<p>8</p>  <p>Press panel into place</p>
<p>9</p>  <p>Use panel support while adhesive dries</p>	<p>10</p>  <p>Once adhesive has dried, remove panel. Replace and engage one click to adjust panel to find correct position</p>	<p>11</p>  <p>Once panel is in correct location, engage second click by pressing panel into final position.</p>	<p>NEW</p> <p>Stratlock SL-RLE shown, available 2021</p>



INSTALLATION GUIDE

SL-FB Stratlock® Range - Screw Fix

SL-FB-FR Stratlock® Range - Screw Fix - Fire Rated

<p>SL-FB</p> 	<p>SL-FB-FR</p> 	<p>USE WITH:</p> <p>SL-M10, SL-M18, SL-M18-FR</p> 	<p>INSTALL WITH:</p> <p>#8 screws #5 screws CP-01ST</p> 
--	--	--	--

INSTALLATION STEPS Screw-fix method - follow same steps for fire-rated Stratlock clips

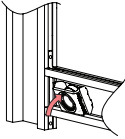
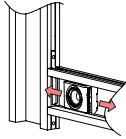
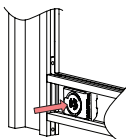
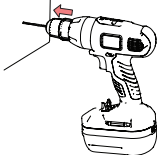
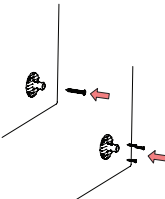
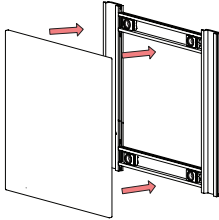
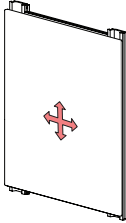
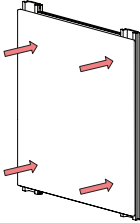
<p>1 Push fit SL-FB into frame</p> 	<p>2 Locate SL-FB into correct position</p> 	<p>3 Insert CP-01 ST into SL-FB and press panel into correct position, marking the panel</p> 	<p>4 Drill out mark created by CP-01ST with 3mm drill bit</p> 
<p>5 Install SL-M18 with 1 x #8 screw through centre or 3 x #5 screws through base</p> 	<p>6 Engage panel to first click into SL-FB</p> 	<p>7 Adjust panel to find correct position</p> 	<p>8 Once panel is in correct location, engage second click by pressing panel into final position</p> 

! NEW
Stratlock SL-RLE shown,
available 2021

COMING SOON

STRATLOCK SL RANGE

STRATLOCK RAIL SYSTEM
BY FASTMOUNT

SL-FB Stratlock® Range - Adhesive Fix

SL-FB

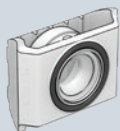

USE WITH:

SL-M10, SL-M18

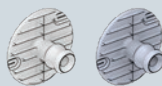

INSTALL WITH:

Fastmount SuperGroove®
Adhesive

INSTALLATION STEPS Adhesive fix method

1 Push fit SL-FB into frame

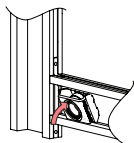

2 Locate SL-FB into correct position

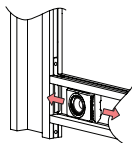

3 Engage SL-M18 two clicks into SL-FB

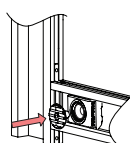

4 Apply Fastmount SuperGroove Adhesive CG-5010 to SL-M18

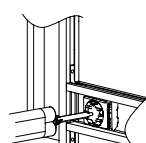

5 Press panel into place

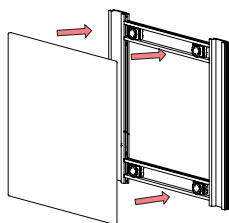

6 Use panel support while adhesive dries

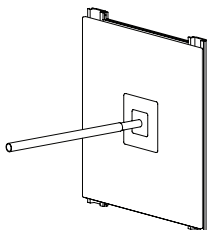

7 Once adhesive has dried, remove panel. Replace and engage only one click to adjust panel around the SL-M18's point

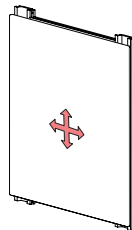

8 Once panel is in desired location, engage second click by pressing panel into its final position

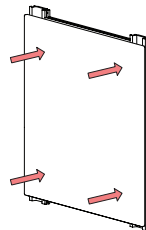

NEW

Stratlock SL-RLE shown,
available 2021



INSTALLATION GUIDE

SL-SFA Stratlock® Range - Screw Fix

SL-SFA-FR Stratlock® Range - Screw Fix - Fire Rated

<p>SL-SFA SL-SFA-FR</p>	<p>USE WITH:</p> <p>SL-M10, SL-M18, SL-M18-FR</p>	<p>INSTALL WITH:</p> <p>CP-01ST</p> <p>2 x #8 panhead screws (20mm, timber frame) OR #8 tek screws (20mm, aluminium/steel frame) #5 screws</p>
--	--	---

INSTALLATION STEPS Screw-fix method - follow same steps for fire-rated Stratlock clips

Note: Refer into steps 6 - 11 on SL-FA Adhesive Fix Installation Guide for adhesive application.

<p>1</p> <p>Position SL-SFA along frame</p>	<p>2</p> <p>Screw into position using 2 x #8 pan head 20mm screws (timber) OR #8 tek 20mm screws (steel/alum.)</p>	<p>3</p> <p>Press CP-01ST centrepoint into SL-SFA, press panel onto point</p>	<p>4</p> <p>Drill out mark created by CP-01ST with 3mm drill bit</p>
<p>5</p> <p>Install SL-M18 with 1 x #8 screw through centre or 3 x #5 screws through base</p>	<p>6</p> <p>Engage panel to first click of SL-M18 into SL-SFA</p>	<p>7</p> <p>Adjust panel to find correct position</p>	<p>8</p> <p>Once panel is in correct location, engage second click by pressing panel into final position.</p>

STRATLOCK SL RANGE

SL-FC Stratlock® Range - Screw Fix

SL-FC-FR Stratlock® Range - screw fix - Fire Rated

SL-FC	SL-FC-FR	USE WITH:	INSTALL WITH:
		SL-M10, SL-M18, SL-M18-FR	#5 screws #8 screws CP-01ST
			

INSTALLATION STEPS Screw-fix method - follow same steps for fire-rated Stratlock clips

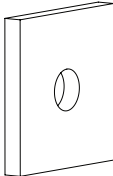
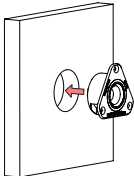
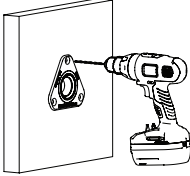
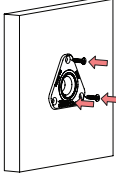
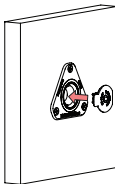
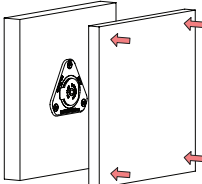
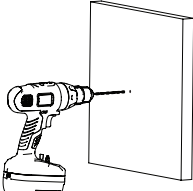
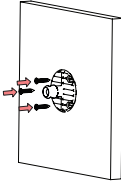
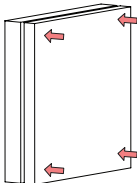
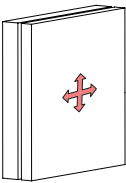
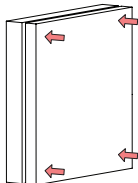
<p>1 Drill out 40mm hole</p> 	<p>2 Press SL-FC into hole</p> 	<p>3 Pre-drill 2.5-3mm holes depending on substrate density</p> 	<p>4 Fasten SL-FC with 3 x #5 screws</p> 
<p>5 Fit CP-01ST into SL-FC</p> 	<p>6 Position panel and press firmly against CP-01ST to mark position of male clip</p> 	<p>7 Drill out mark created by CP-01ST with drill bit according to fitting preference (1 or 3 screws)</p> 	<p>8 Install SL-M18 / SL-M10 with either 1 x #8 screw or 3 x 5 screws according to preference.</p> 
<p>9 Engage panel to first click of SL-M18/SL-M10</p> 	<p>10 Adjust panel to find desired position</p> 	<p>11 Once panel is in correct location, engage second click by pressing panel into final position</p> 	

SL-FC Stratlock® Range - Adhesive Fix

<p>SL-FC</p> 	<p>USE WITH:</p> <p>SL-M10 , SL-M18</p> 	<p>INSTALL WITH:</p> <p>Fastmount SuperGroove® Adhesive #5 screws</p>
---	--	--

INSTALLATION STEPS Adhesive fix method

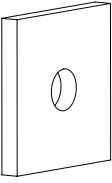
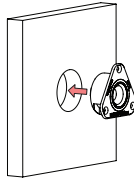
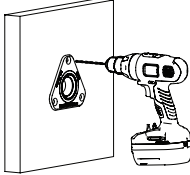
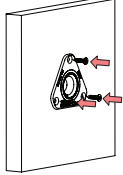
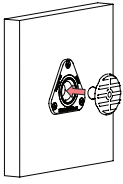
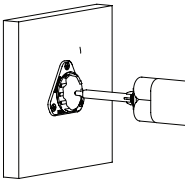
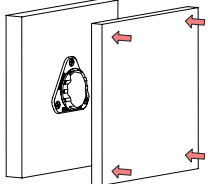
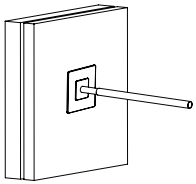
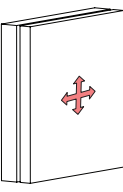
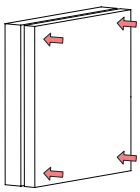
<p>1 Drill out 40mm hole</p> 	<p>2 Fit SL-FC into hole</p> 	<p>3 Pre-drill 2.5-3mm holes depending on substrate density</p> 	<p>4 Fasten SL-FC with 3 x #5 screws</p> 
<p>5 Clip SL-M18 / SL-M10 into SL-FC</p> 	<p>6 Apply Fastmount SuperGroove Adhesive to the back of male clip</p> 	<p>7 Press panel against clips in desired position</p> 	<p>8 Support panel in place while adhesive dries</p> 
<p>9 Use CT-05 to disengage panel. To replace, engage one click and adjust panel to find correct position</p> 	<p>10 Once panel is in correct location, engage second click by pressing panel into final position</p> 		

PANELSAFE PS RANGE

PS-150 PanelSafe - Self Tapping Male



SPECIFICATIONS:

PanelSafe restraint systems The PS-150 is for use with substrates with a cavity behind that can accommodate the spring, provide added security and control. The panel is suspended below the ceiling for convenient servicing behind the panel or controlled removal of the panel by releasing the wire. For use with Fastmount clips and installation tools.

Standard 150mm drop, custom lengths available on request.



PS-150

USE WITH:

- PC Standard Range
- LP Low Profile Range
- VL Very Low Profile Range
- MC Metal Range

MORE INFO:

- Installation Guide PS-150
- Clip Layout Guide PS-150

MATERIAL:

Aluminium and stainless steel

PANELSAFE PS RANGE

BENEFITS

- Provides extra security for heavy panels
- Easy one-person removal of large panels
- Convenient servicing behind panel without full removal
- Prevents panels falling during fire exit
- Works with existing Fastmount clips
- Variable length to suit application
- Self tapping option available

APPLICATIONS

- Heavy panels
- Large panels
- Thin walled panels requiring adhesive mounting
- Inspection and service panels
- Panels above valuable furniture and artwork

INSTALLATION: Partially exploded through section showing typical installation method

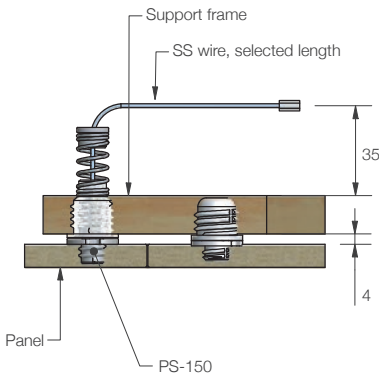

Cut away view, panel open

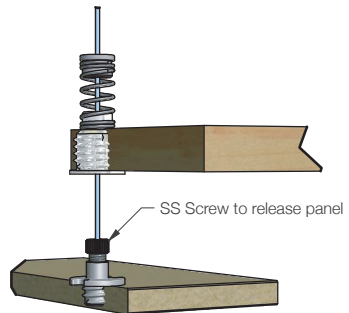

PS-150E PanelSafe Easy Fit - Self Tapping Male**SPECIFICATIONS:**

PanelSafe Easy Fit restraint systems provide added security and control. The panel is suspended below the ceiling for convenient servicing behind the panel or controlled removal of the panel by releasing the wire. For use with Fastmount system clips and installation tools. The PS-150 is for use with substrates with a cavity behind that can accommodate the spring.

PANELSAFE PS RANGE**BENEFITS**

- Provides extra security for heavy panels
- Easy one person removal of large panels
- Convenient servicing behind panel without full removal
- Prevents panels falling during fire exit
- Works with existing Fastmount clips
- Variable length to suit application
- Surface mount option available

APPLICATIONS

- Heavy panels
- Large panels
- Inspection and service panels
- Panels above valuable furniture and artwork

PS-150E

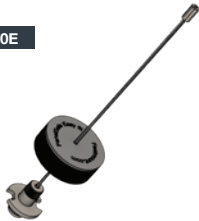
**USE WITH:**

- PC** Standard Range
- LP** Low Profile Range
- VL** Very Low Profile Range
- MC** Metal Range

MORE INFO:

- Installation Guide PS-150E
- Clip Layout Guide PS-150E page 84

MATERIAL:

Aluminium and stainless steel

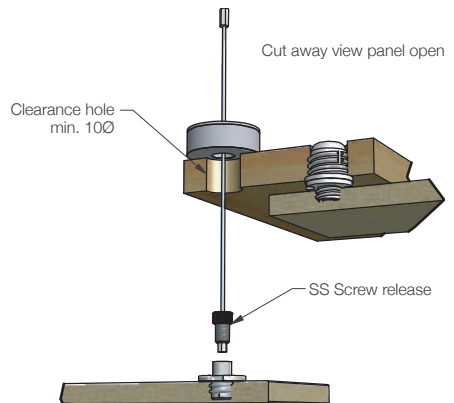
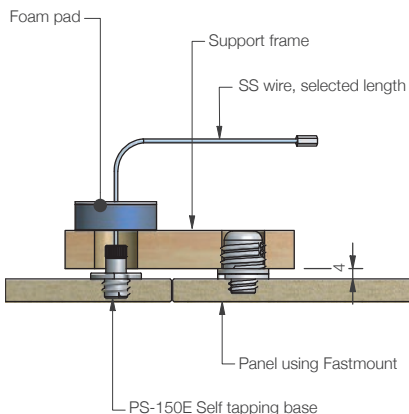
INSTALLATION: Partially exploded through section showing typical installation method

PANELSAFE PS RANGE

PRODUCT SHEET

PS-S150E PanelSafe Easy Fit - Surface Mount



SPECIFICATIONS:

PANELSAFE PS RANGE

PanelSafe Easy Fit restraint systems provide added security and control. The panel is suspended below the ceiling for convenient servicing behind the panel or controlled removal of the panel by releasing the wire. For use with Fastmount system clips and installation tools. The PS-S150E is for use with substrates with a cavity behind that can accommodate the spring.

PS-S150E



USE WITH:

- PC** Standard Range
- LP** Low Profile Range
- VL** Very Low Profile Range
- MC** Metal Range

MATERIAL:

Aluminium and stainless steel

MORE INFO:

Installation Guide PS-150E
Clip Layout Guide PS-150E

BENEFITS

- Provides extra security for heavy panels
- Easy one person removal of large panels
- Convenient servicing behind panel without full removal
- Prevents panels falling during fire exit
- Works with existing Fastmount clips
- Variable length to suit application
- Self tapping option available

APPLICATIONS

- Heavy panels
- Large panels
- Thin walled panels requiring adhesive mounting
- Inspection and service panels
- Panels above valuable furniture and artwork

INSTALLATION: Partially exploded through section showing typical installation method

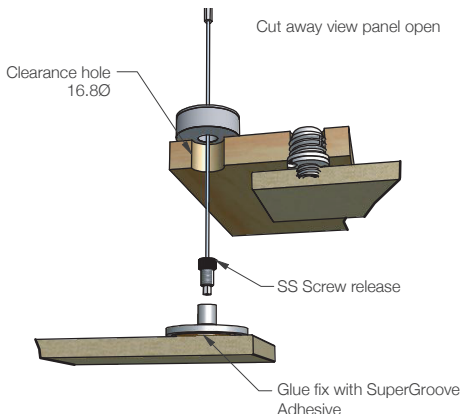
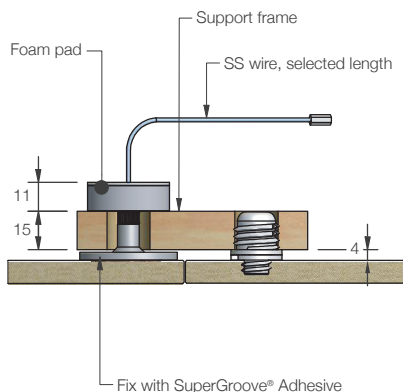

Safe and secure.
Fast and easy.



An extension of the Fastmount PanelSafe range, the Seismount provides added security and ease of dismount for removable ceiling and wall panels. With the high volume, commercial customer in mind, its design was taken back to basics to deliver a cost effective system without sacrificing high performance, boasting a 144kg drop load resistance. Peace of mind on every panel.



Panel restraint solution:
PS-SR225S Seismount
Galvanised Steel – 225mm

PANELSAFE PS RANGE

PS-SR225S Seismount™ Galvanised Steel – 225mm



SPECIFICATIONS:

The PanelSafe Seismount in galvanised steel is a strong solution for high volume architectural installation where added security and control of the panel is required. The Seismount allows the panel to be suspended below the ceiling for convenient servicing behind the panel or controlled removal of the panel. Install with M10 pan head screw or 6.3 x 8mm euro screw. Simply unhook the strap from the screws to remove the panel.

Drop length 225mm. 144kg break load for the PS-SR225S in both wall and ceiling applications.

PS-SR225S



USE WITH:

- PC Standard Range
- LP Low Profile Range
- VL Very Low Profile Range
- MC Metal Range
- SL Stratlock Range

MATERIAL:

Galvanised steel

PANELSAFE PS RANGE

BENEFITS

- Low cost solution for high volume applications
- No special tools required for installation
- Install directly onto substrate face with screws
- Controlled removal of large panels
- Seismic security for overhead panels – prevents panels from falling

APPLICATIONS

- Ceiling panels
- Wall panels
- Large panels
- Inspection and service panels

INSTALLATION: Partially exploded through section showing typical installation method

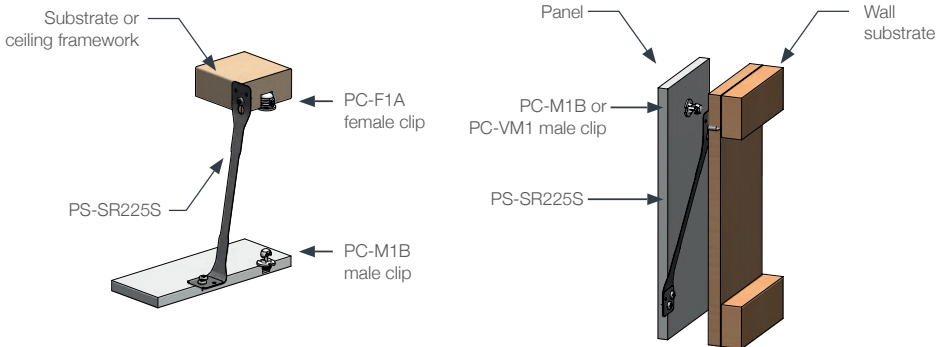

PS-SR225SS Seismount™ Stainless Steel – 225mm**SPECIFICATIONS:**

The PanelSafe Seismount in stainless steel is a strong solution for high volume marine installations where added security and control of the panel is required. The Seismount allows the panel to be suspended below the ceiling for convenient servicing behind the panel or controlled removal of the panel. Install with M10 pan head screw or 6.3 x 8mm euro screw. Simply unhook the strap from the screws to remove the panel.

Drop length 225mm. 144kg break load for the PS-SR225SS in both wall and ceiling applications.

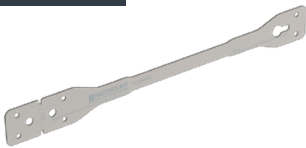
PS-SR225SS**USE WITH:**

- PC** Standard Range
- LP** Low Profile Range
- VL** Very Low Profile Range
- MC** Metal Range
- SL** Stratlock Range

MATERIAL:

Stainless steel

PANELSAFE PS RANGE**BENEFITS**

- Low cost solution for high volume applications
- No special tools required for installation
- Install directly onto substrate face with screws
- Controlled removal of large panels
- Seismic security for overhead panels – prevents panels from falling
- Stainless steel composition for longevity in marine applications

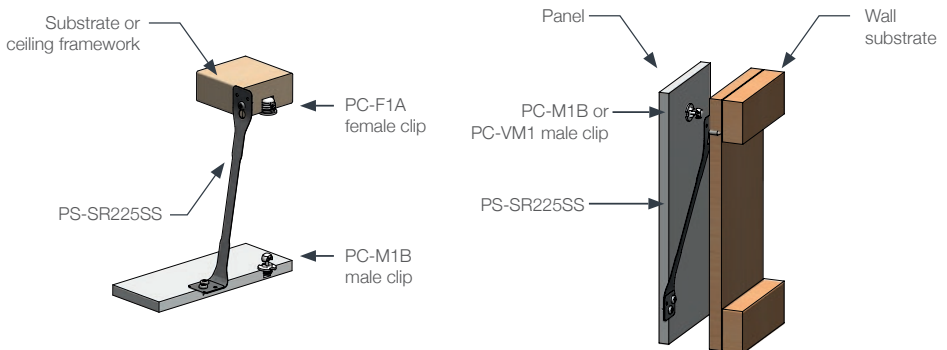

APPLICATIONS

- Ceiling panels
- Wall panels
- Large panels
- Inspection and service panels

INSTALLATION: Partially exploded through section showing typical installation method

PANELSAFE PS RANGE

PS-150 PanelSafe Restraint System

 <p>PS-150</p>	<p>USE WITH:</p> <p>PC Standard Range LP Low Profile Range VL Very Low Profile Range MC Metal Range</p>	<p>INSTALL WITH:</p> <p>CP-01ST CT-01 CT-09 CT-07 CT-03 CT-10</p> 
--	---	---

INSTALLATION STEPS Page 1

- Drill hole through panel and frame

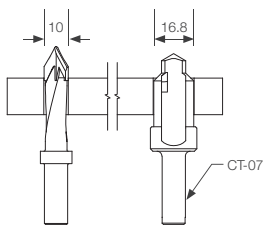
- Screw PanelSafe in 16.8Ø hole

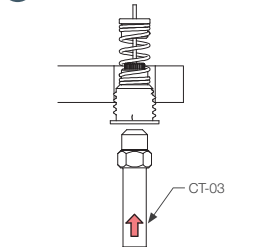

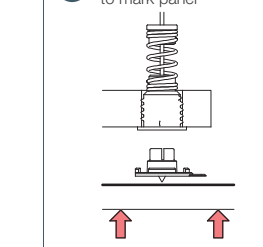
- Fit CP-01ST into PanelSafe to mark panel

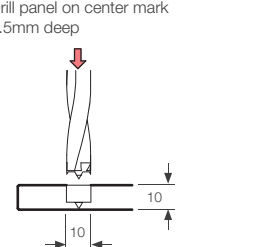

- Drill panel on center mark 7.5mm deep

- Screw fit PS-M with CT-10

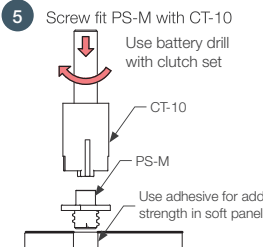
Use battery drill with clutch set

Use adhesive for additional strength in soft panels

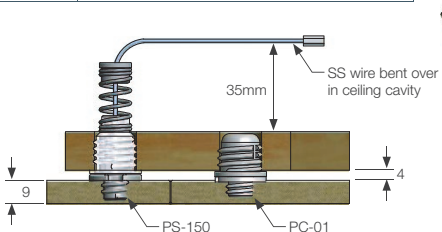
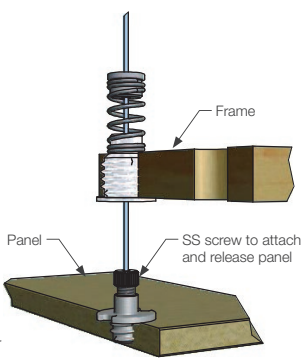
- Completed installation





PS-150 PanelSafe Restraint System

 <p>PS-150</p>	<p>USE WITH:</p> <ul style="list-style-type: none"> PC Standard Range LP Low Profile Range VL Very Low Profile Range MC Metal Range 	<p>INSTALL WITH:</p> <div style="display: flex; justify-content: space-around;"> <div data-bbox="772 430 817 534"> <p>CT-03</p>  </div> <div data-bbox="851 430 896 534"> <p>CT-10</p>  </div> </div>
--	--	--

INSTALLATION STEPS Page 2

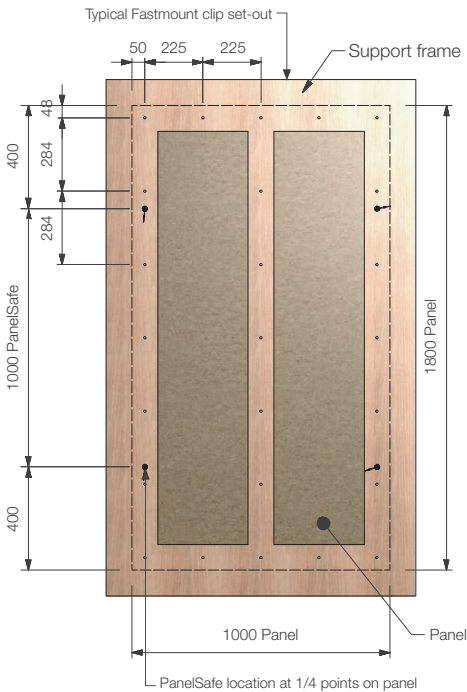
- A** Plan view of panel from above with 4 x PanelSafe
 Larger or more flexible panels may require extra PanelSafes for correct support. Each PanelSafe has a static load of 150kgs and a drop load of 10kgs.



- B** End view with panel down

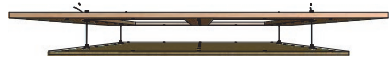



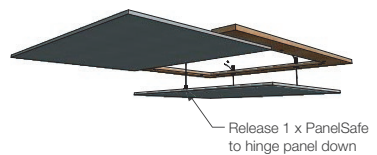



- C** End view with panel down

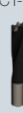

PANELSAFE PS RANGE

PS-150E & PS-S150E PanelSafe Easy Fit Restraint System

<div style="display: flex; justify-content: space-around;"> <div style="text-align: center;"> <p>PS-150E</p>  </div> <div style="text-align: center;"> <p>PS-S150E</p>  </div> </div>	<p>USE WITH:</p> <ul style="list-style-type: none"> PC Standard Range LP Low Profile Range VL Very Low Profile Range MC Metal Range 	<p>INSTALL WITH:</p> <div style="display: flex; justify-content: space-around; align-items: center;"> <div style="text-align: center;"> <p>CP-01ST</p>  </div> <div style="text-align: center;"> <p>CT-01</p>  </div> <div style="text-align: center;"> <p>CT-09</p>  </div> <div style="text-align: center;"> <p>CT-07</p>  </div> <div style="text-align: center;"> <p>CT-10</p>  </div> </div>
--	--	--

INSTALLATION STEP OPTIONS Refer to product sheets PS-150E & PS-S150E for more information

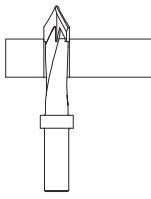
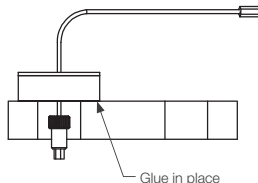
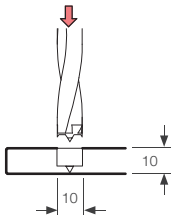
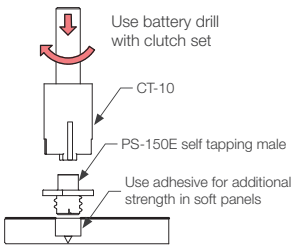
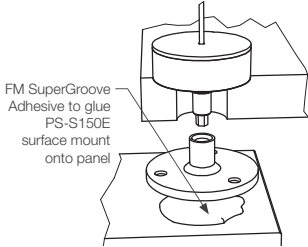
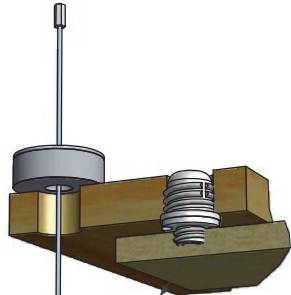
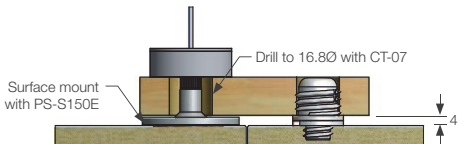
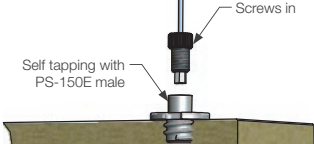
<p>1 Drill hole through support frame</p> 	<p>2 Fit PanelSafe in 10Ø to 16.8Ø hole</p>  <p>Glue in place</p>	<p>3 Self tapping screw in option. Drill panel on center mark 7.5mm deep.</p> 
<p>4 Screw fit PS-M with CT-10</p>  <p>Use battery drill with clutch set</p> <p>CT-10</p> <p>PS-150E self tapping male</p> <p>Use adhesive for additional strength in soft panels</p>	<p>Surface mount option</p>  <p>FM SuperGroove Adhesive to glue PS-S150E surface mount onto panel</p>	 <p>Screws in</p>
<p>6 Completed installation</p>  <p>Surface mount with PS-S150E</p> <p>Drill to 16.8Ø with CT-07</p> <p>4</p>		 <p>Self tapping with PS-150E male</p>

PS-150E & PS-S150E PanelSafe Easy Fit Restraint System

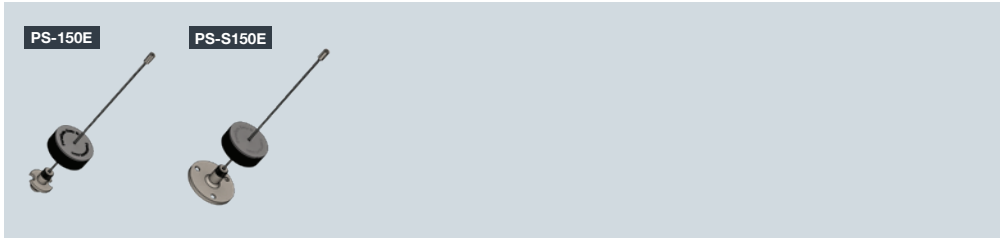

INSTALLATION STEP OPTIONS

- A** Plan view of panel from above with 4 x PanelSafe
Larger or more flexible panels may require extra PanelSafes for correct support. Each PanelSafe has a static load of 150kgs and a drop load of 10kgs.

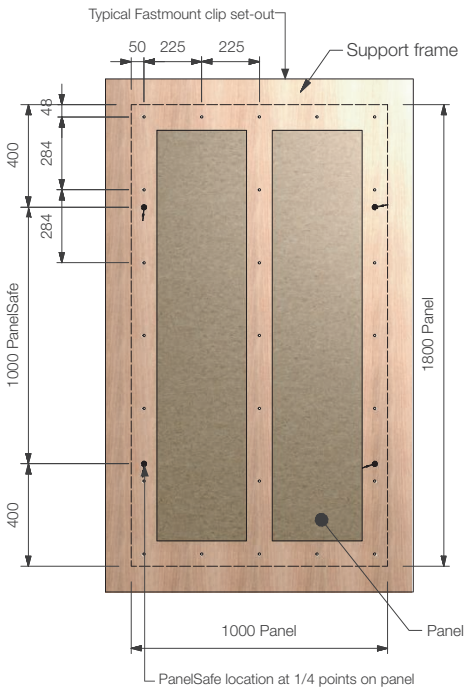

- B** End view with panel down

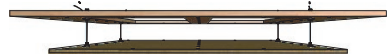

- C** Plan view of small panel from above with 3 x PanelSafe

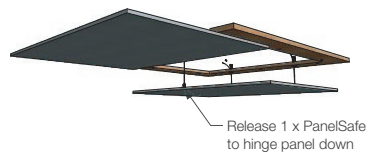

PANELSAFE PS RANGE

PS-SR225S & PS-SR225SS Seismount – 225mm

<p>PS-SR225S</p> <p>PS-SR225SS</p>	<p>USE WITH:</p> <ul style="list-style-type: none"> PC Standard Range LP Low Profile Range VL Very Low Profile Range MC Metal Range SL Stratlock Range 	<p>INSTALL WITH:</p> <p>M10 pan head screw 6.3 x 8mm euro screw</p>
--	---	--

INSTALLATION STEPS FOR WALLS

<p>1</p> <p>PS-SR225S</p> <p>Fold tab over completely along dotted line</p>	<p>2</p> <p>Partially screw M10 pan-head screw into substrate</p> <p>Wall substrate</p> <p>PC-F1A female clip</p>	<p>3</p> <p>Panel</p> <p>PC-M1B male clips</p> <p>Measure 225mm below x-y point for location of PS-SR225S on panel</p>
<p>4</p> <p>Screw folded end of PS-SR225S onto panel with 1 x 6.3 x 8mm Euro screw plus 2 x M8 pan-head screws</p> <p>Panel</p> <p>PS-SR225S</p> <p>note: length of screws to suit panel thickness</p>	<p>5</p> <p>Slot the PS-SR225S onto pan-head screw on substrate and tighten screw</p> <p>Panel</p> <p>Wall substrate</p> <p>PC-F1A female clip</p>	<p>6</p> <p>Wall substrate</p> <p>Clip panel in place</p> <p>PC-M1B male clips</p> <p>PS-SR225S</p>

PS-SR225S & PS-SR225SS Seismount – 225mm

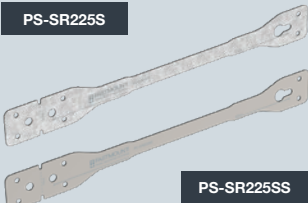
 <p>PS-SR225S</p> <p>PS-SR225SS</p>	<p>USE WITH:</p> <ul style="list-style-type: none"> PC Standard Range LP Low Profile Range VL Very Low Profile Range MC Metal Range SL Stratlock Range 	<p>INSTALL WITH:</p> <p>M10 pan head screw 6.3 x 8mm euro screw</p>
---	---	--

INSTALLATION STEPS FOR CEILINGS

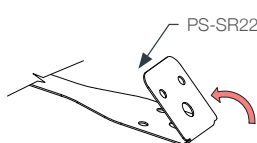
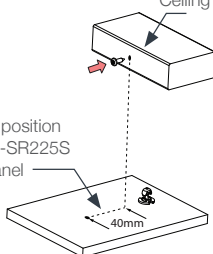
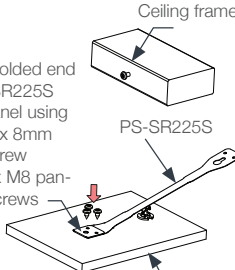
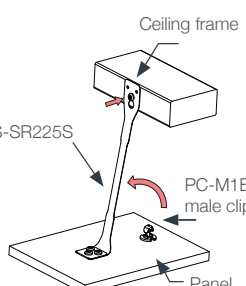
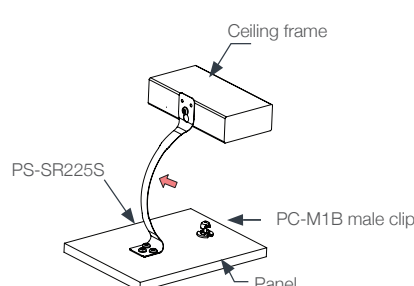
<p>1</p>  <p>PS-SR225S</p> <p>Fold tab over completely along dotted line</p>	<p>2</p> <p>Partially screw M10 pan-head screw into substrate</p>  <p>Ceiling frame</p> <p>Mark position of PS-SR225S on panel</p> <p>40mm</p>	<p>3</p>  <p>Ceiling frame</p> <p>PS-SR225S</p> <p>Panel</p> <p>Screw folded end of PS-SR225S onto panel using 1 x 6.3 x 8mm Euro screw plus 2 x M8 pan-head screws</p> <p>note: screw length to suit panel thickness</p>
<p>4</p> <p>Fold up SR and slot the PS-SR225S onto screw in substrate and tighten screw</p>  <p>Ceiling frame</p> <p>PS-SR225S</p> <p>PC-M1B male clip</p> <p>Panel</p>	<p>5</p> <p>Before pushing panel into position on substrate, ensure that PS-SR225S is bent inwards to ensure correct bending function when clipping panel into place inwards to encourage correct bend orientation</p>  <p>Ceiling frame</p> <p>PS-SR225S</p> <p>PC-M1B male clip</p> <p>Panel</p>	

TEXTILE TC RANGE

TC-F6H Textile Clip Female - Heavy Duty



SPECIFICATIONS:

TEXTILE CLIPS TC RANGE

Designed for textiles and soft furnishings, the TC-F6H sews onto upholstery for a heavy-duty fixing to interior and exterior surfaces. The transparent slide-lock mechanism ensures the strongest hold to the male clip and easy cushion removal without force. Slider can be replaced in-situ without removing saddle in the event of damage.

TC-F6H



USE WITH

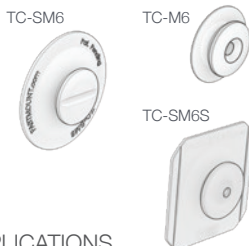

MATERIAL:

UV stabilised polycarbonate
UV stabilised nylon

APPLICATIONS

- Exterior cushions
- Internal seating areas
- Sundeck mattresses and sunbeds
- Foredeck mounted mattresses
- Sun loungers

BENEFITS

- TC-F6H sews onto cushion at upholstery construction stage
- Enables heavy-duty attachment of soft furnishings to painted or gel coat surfaces
- Enables secure attachment of cushions to fabric when used with TC-SM6S
- Slide lock mechanism makes soft furnishings quick to install and easy to remove
- High quality, secure finish
- Heavy duty break out load of 26kg with TC-M6 & TC-SM6S or 32kg with TC-SM6
- No force required to release lock. Pull tab towards edge of the cushion to unlock and remove
- Hidden fixing – no visible domes, screws, straps or hook and loop tape. Low visibility transparent lock tab when exposed
- Sliding lock can be replaced without unstitching saddle in the event of damage
- No removal tool required

INSTALLATION:

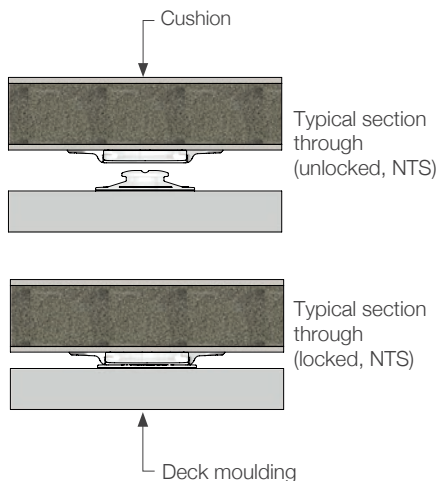
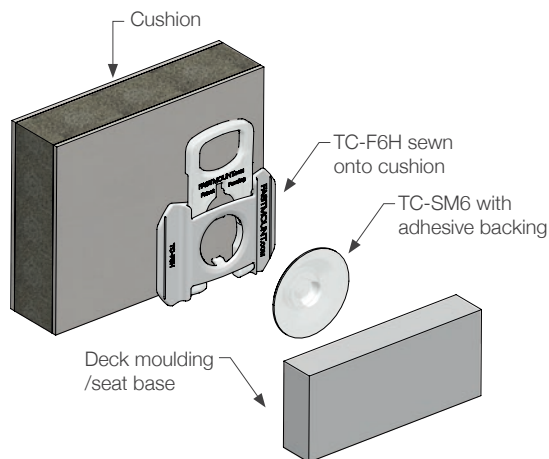



Holds fast.
Releases quick.

The TC-F6H for upholstery.

Custom-built furniture should be installed with purpose-built fixings. The Textile Range was designed specifically for fixing cushions and upholstery quickly and securely. Featuring an intuitive slide-lock mechanism, the TC-F6H female physically locks cushions into position when combined with the TC-M6, TC-SM6 or TC-SM6S. Slide to release, slide to replace, with no extra effort.



Panel mounting solution:

TC-F6H - cushion

TC-SM6S - fabric

TEXTILE TC RANGE

TC-M6 Male Clip



SPECIFICATIONS:

The TC-M6 fixes to a seat base, deck or other substrate with a #5 screw for a mechanical fixing to hard surfaces. The head of the clip engages with the TC-F6H for a 26kg break load. Ideal for both fastening both interior and exterior upholstery.

TC-M6



MATERIAL:
UV stabilised nylon

USE WITH

TC-F6H



APPLICATIONS

- Exterior cushions
- Sundeck mattresses
- Foredeck mounted mattresses
- Seating areas external & internal
- Crew and guest areas

TEXTILE CLIPS TC RANGE

BENEFITS

- Screw fixes to deck or substrate
- Enables the attachment of soft furnishings to hard surfaces
- Makes furnishings quick to install, and easy to remove
- High quality, secure finish
- Easy alignment to replace the cushion, clip locks into place
- Purpose built
- Saves removal time for staff and crew
- Invisible fixing – no visible domes, screws, straps or hook and loop
- Break load of 26kg when used with TC-F6H

INSTALLATION: Partially exploded through section showing typical installation method

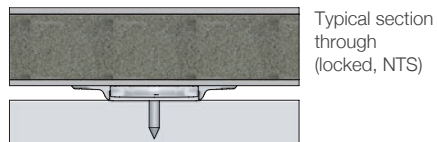
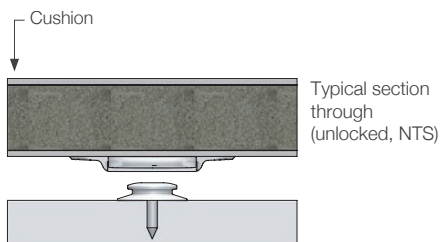
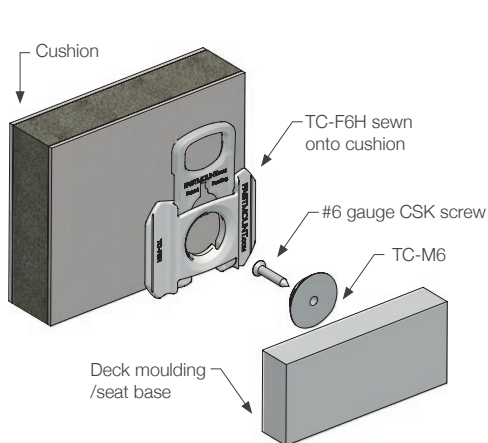

TC-SM6S Sew on male clip



SPECIFICATIONS:

The TC-SM6S is designed to be used with the TC-F6H for fabric-to-fabric upholstery fixing. The TC-SM6S is sewed to the fabric at the upholstery stage, and locks into the TC-F6H for secure fixing of upholstery and cushions. A hidden fixing ideal for sunbeds, interior and exterior furniture.

TEXTILE CLIPS TC RANGE

BENEFITS

- Sew on during upholstery stage
- Fabric to fabric fixing
- Enables rapid removal and replacement of cushions
- Invisible fixing
- Simple installation with no special tools
- Foolproof alignment
- No force required to remove

APPLICATIONS

- Exterior cushions
- Sundeck mattresses
- Seating areas external & internal
- Crew and guest areas
- Sunbeds
- Hotels

TC-SM6S



NEW !

USE WITH

TC-F6H



MATERIAL:

Translucent UV stabilised nylon

INSTALLATION: Partially exploded through section showing typical installation method

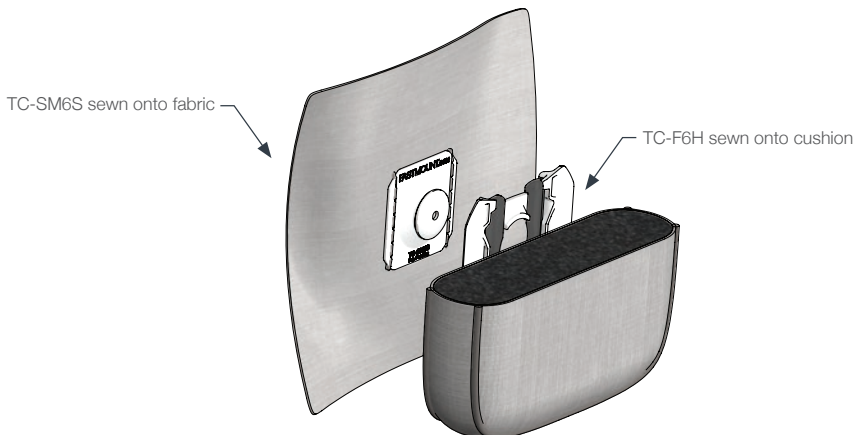

TEXTILE TC RANGE

TC-SM6 Textile Clip Male - VHB Adhesive



SPECIFICATIONS:

The TC-SM6 is a white surface mount male clip with self-adhesive VHB backing for rapid and durable installation of soft furnishings. Clip attaches to hard surface and compatible with TC-F6H from the Textile Range.

TEXTILE CLIPS TC RANGE

BENEFITS

- VHB self-adhesive fix
- Enables attachment of soft furnishings to painted or gelcoat surfaces
- Makes furnishings quick to install, and easy to remove
- High quality, secure finish
- Easy alignment to replace the cushion, clip locks into place
- Purpose built
- Saves removal time for staff and crew
- Invisible fixing – no visible domes, screws, straps or hook and loop
- Break load of 32kg when used with TC-F6H
- Change to VHB tape is UV stabilised, bonds extremely well to painted, smooth flat surfaces.
- No penetrations or screw holes in deck structure when using TC-SM6

TC-SM6



USE WITH

TC-F6H



MATERIAL:

UV stabilised nylon

APPLICATIONS

- Exterior cushions
- Sundeck mattresses
- Foredeck mounted mattresses
- Seating areas external & internal
- Crew and guest areas

INSTALLATION: Partially exploded through section showing typical installation method

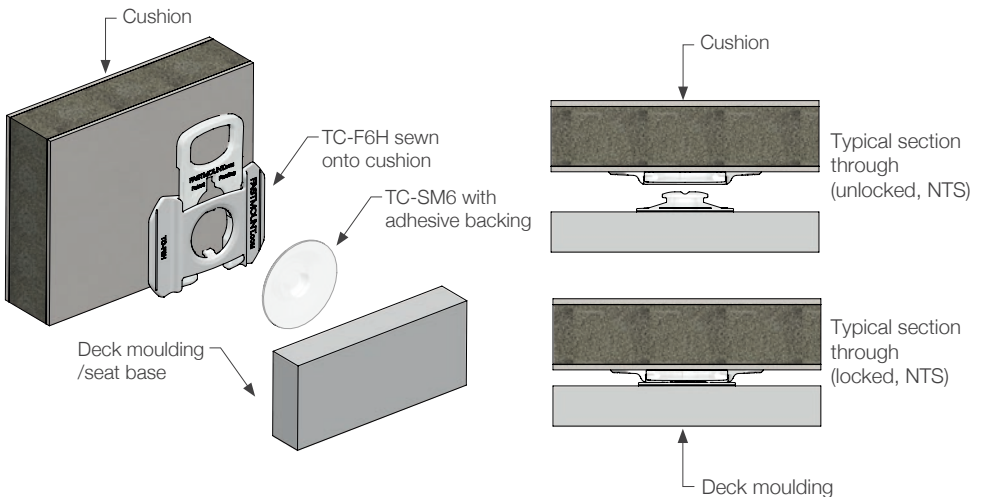

TC-F6H & TC-SM6 Textile Clip Range

TC-F6H



TC-SM6



USE WITH:

Upholstery sewing machine using standard foot, size 110/18 needle and V92 thread.

For optimum adhesion, wipe the mounting surface clean with alcohol or solvent wipe and dry before pressing TC-SM6 to surface. Wait 24 - 72 hours before installing cushions.

INSTALLATION STEPS:

- 1** Sew TC-F6H to fabric using 110/18 needle and V92 size thread along stitch groove.

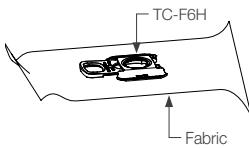

- 1B** Close up of TC-F6H sewn on

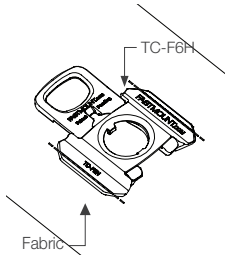

- 2** Complete cushion assembly

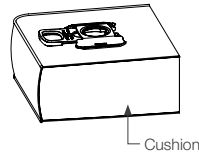

- 3** Insert TC-SM6 into TC-F6H

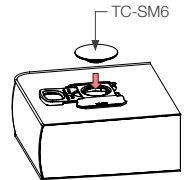

- 4** Lock TC-F6H

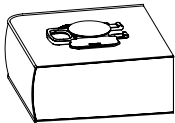

- 5** Peel off TC-SM6 backing

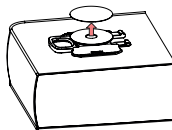

- 6** Align cushion in position

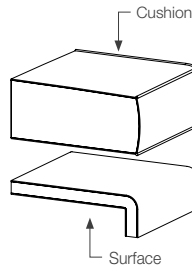

- 7** Press down firmly in place. To disengage, pull slide lock towards edge of cushion.

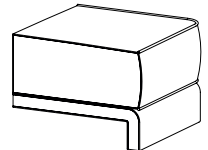

TEXTILE TC RANGE

TC-F6H & TC-M6 Textile Clip Range

TC-F6H	TC-M6	USE WITH:	INSTALL WITH:
		Upholstery sewing machine using standard foot, size 110/18 needle and V92 thread. #6 screw	TC-CP6H

INSTALLATION STEPS

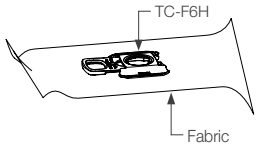
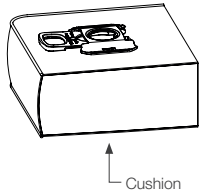
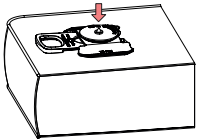
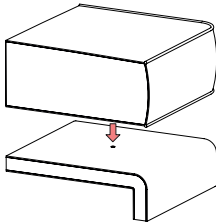
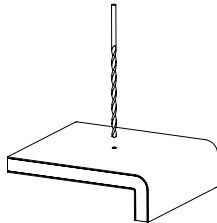
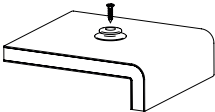
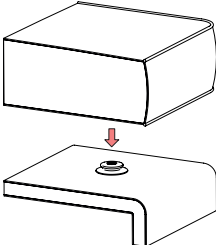
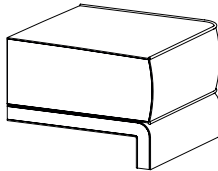
<p>1 Sew TC-F6H to fabric using 110/18 needle and V92 size thread along stitch groove.</p> 	<p>2 Complete cushion assembly.</p> 	<p>3 Insert TC-CP6H into TC-F6H. Press slider to hold TC-CP6H in place.</p> 	<p>4 Align cushion and press firmly on mounting surface.</p> 
<p>5 Drill on mark.</p> 	<p>6 Screw TC-M6 onto base using #6 gauge CSK screw.</p> 	<p>7 Align cushion with TC-M6.</p> 	<p>7 Press cushion into place. To engage, slide lock away from cushion edge, to disengage, pull lock towards edge.</p> 

TC-F6H & TC-SM6S Textile Clip Range

TC-F6H





TC-SM6S



USE WITH:

Upholstery sewing machine using standard foot, size 110/18 needle and V92 thread.

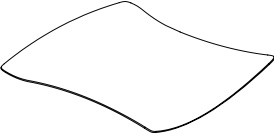
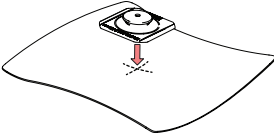
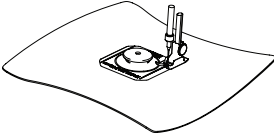
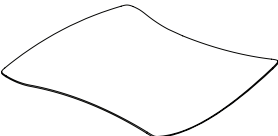
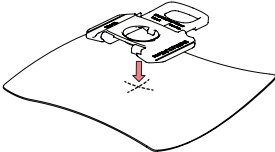
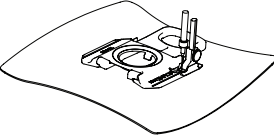
INSTALLATION STEPS

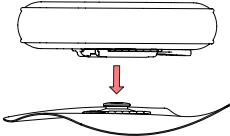
<p>1 Cut fabric to shape.</p> 	<p>2 Mark location of TC-SM6S and position clip about 70mm away from edge.</p> 	<p>3 Sew TC-SM6S to fabric using 110/18 needle and V92 size thread along stitch groove.</p> 
<p>4 Cut cushion fabric to shape</p> 	<p>5 Mark location of TC-F6H and position clip about 70mm away from cushion edge</p> 	<p>6 Sew TC-F6H to fabric using 110/18 needle and V92 size thread along stitch groove.</p> 
<p>7 Complete construction of cushion</p> 	<p>8 To lock cushion into place, align clips. To engage, slide lock away from cushion edge, to disengage, pull lock towards edge of cushion.</p> 	

TECHNICAL INFORMATION

Pull out loads

The pull out loads will vary depending on the clip type and are specified on each product sheet. They are generally a minimum 5kg for typical Standard Range clips and 10kg for heavy-duty clips. For extra heavy panels use the PC-VMX with a 15kg pull out load.

The shock load is less and can be as low as 2kg, depending on the type of shock load. Clips never load simultaneously on a panel, so if a panel has 10 clips it does not mean the force required to remove the panel (or the force the panel will take) is 10 x 5kg.

NB. For official SGS performance reports covering pullout loads, repetitive pull out loads and shear loads, please refer to www.fastmount.com

Clip spacing and panel loads

Panels need to be supported evenly around the perimeter to eliminate sagging. The clip spacing requirements will vary depending on the application. Refer to the Fastmount Clip Layout Guides: TD-02, TD-08, TD-09, TD-12, TD-15 and TD-16 at:

www.fastmount.com/en/clip_system/clip_layout_guides

Although many of the Fastmount clip sets will hold more than your potential panel load, the reality of unknown conditions means panels and clips could be subjected to shock loads (g-forces) from huge seas or seismic shocks. From our experience it is best to follow our guidelines and also conduct tests of panel type and substrate on a project-by-project basis.

See pages 96-100 for panel clip setout guides or if you require advice email info@fastmount.com

Fastmount with different materials

You can mount Fastmount clips into or onto most panel products such as plywood, MDF, plastic, fibreglass, HPL, sandwich panels and composite panels such as Alucobond. It is not recommended for use with very heavy materials such as granite or heavy fibre cement board. The LP-DF8 coarse thread female clip is designed to work with drywall plasterboard.

Please refer to the Architectural Clip Selection Guide on pages 101 and 102, and the Marine Clip Selection Guide on pages 103 and 104, showing substrate and product matrices.



Drill setting and self tapping clips

The clutch setting on battery drills when fitting clips varies from drill to drill. It will depend on the battery charge condition and the material you are screwing into.

Once two or three test clips have been fitted, you will have a good feel for a setting that screws the clips home, but does not over tighten them. If the clips are breaking, the drill setting is too powerful.

NOTE: Some hard veneers and hard materials require a small countersink to the entrance of the hole to allow the clip thread to tap into the material. Use CT-12 drill to achieve countersink.

Contact us for advice at info@fastmount.com.

Adhesives for surface mount clips

Our patented SuperGroove® design means the Fastmount surface mount clips use a mechanical engagement to secure the clip, so adhesive selection is mostly dependant on panel material.

A typical two-part epoxy will hold the clip at over three times the clipping load (30-40kg per clip). We recommend the Fastmount SuperGroove Adhesive, a two-part epoxy designed specifically for use with the Fastmount range.

Panel treatment notes (plywood, MDF, composite foam panels)

When selecting the type of finish on your panels, ensure you follow the golden rule of 'balancing' the panel - however you treat the face side of the panel or sheet must be duplicated on the back face of the panel. This is to prevent the panel from warping, due to the unbalanced tension that a single coating or veneer applied to one face of the panel exerts. For example, if the panel face is a paint finish, then the back face will also require a paint finish to balance the tension in the panels. In the case of veneered panels, when applying good veneer on the face side, apply any type of veneer on the back face for the best finish.

As a test to prove this, take a dry plywood or MDF panel approximately 500 x 200mm, coat one face only with water, leave the other face dry and put it in the sun. The panel will warp within hours, which is precisely the same effect as painting one side only, however it may take months for this to happen as moisture is absorbed unevenly from the atmosphere.

Quality installation

To ensure consistent and quality installation, Fastmount supplies tools where required. Installation guides and videos are available for each range on www.fastmount.com

LAYOUT GUIDE FOR SMALL OR LIGHTWEIGHT CEILING PANEL ALL RANGES

TD-02

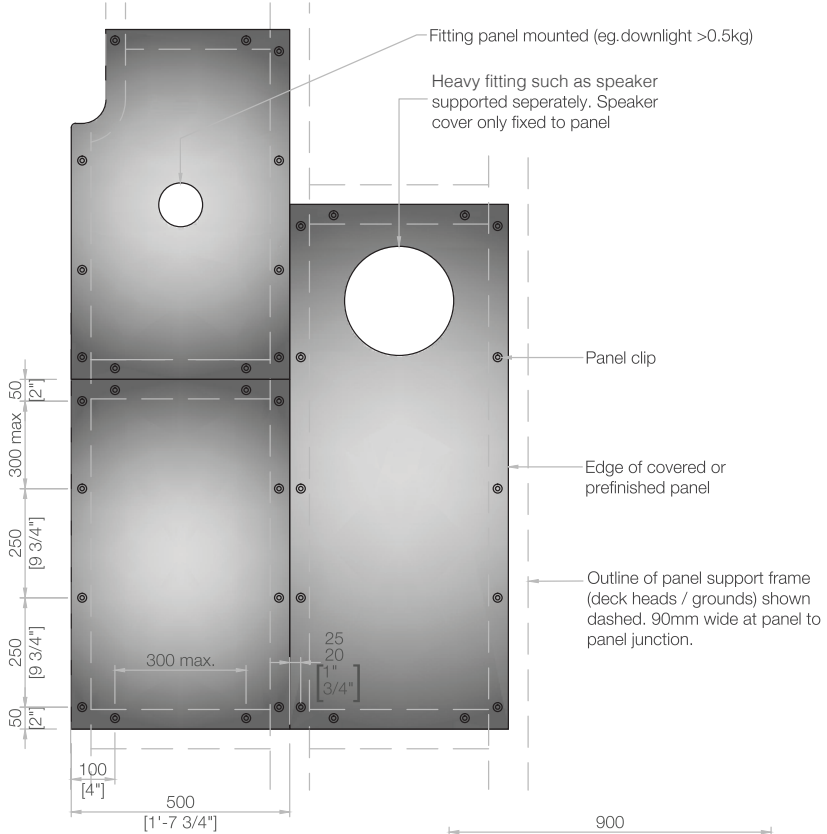

For panels wider than 600 add centre row of clips

Reflected plan view of ceiling panels & support grid.
Read with Fastmount installation instructions.

LAYOUT GUIDE FOR LARGE WALL PANEL LOW PROFILE RANGE



TD-08

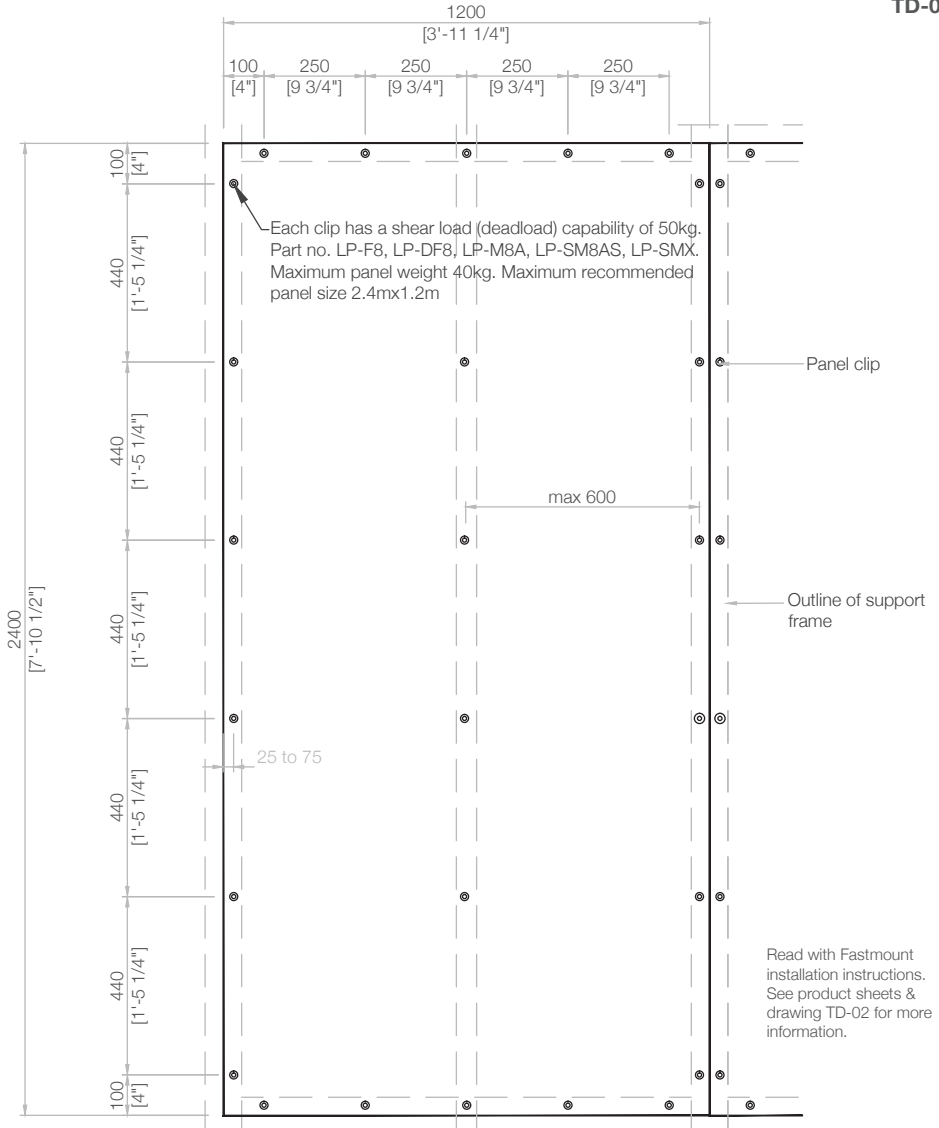

LAYOUT GUIDE FOR LARGE WALL PANEL STANDARD PC RANGE

TD-09

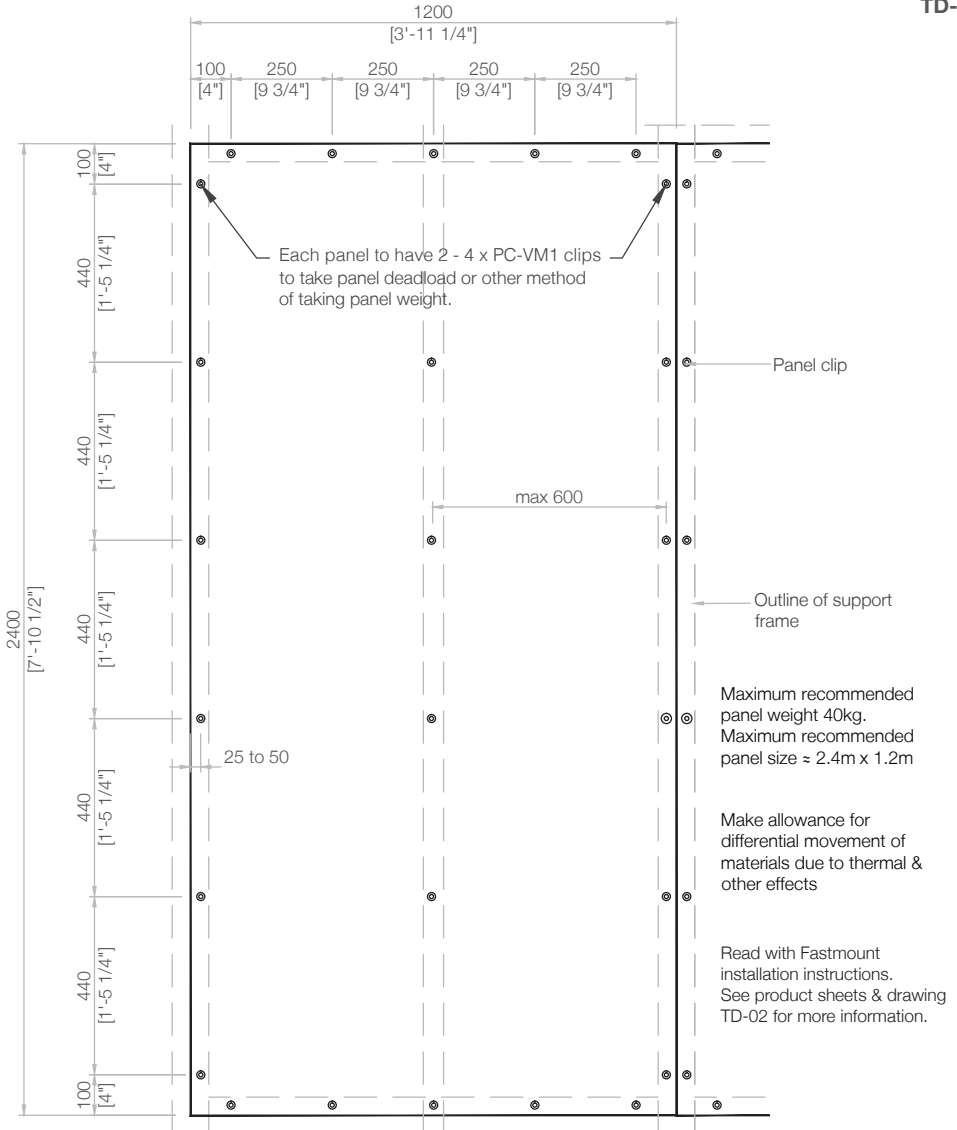

LAYOUT GUIDE FOR HEAVY OR LARGE CEILING PANEL STANDARD PC AND METAL MC RANGES



TD-12

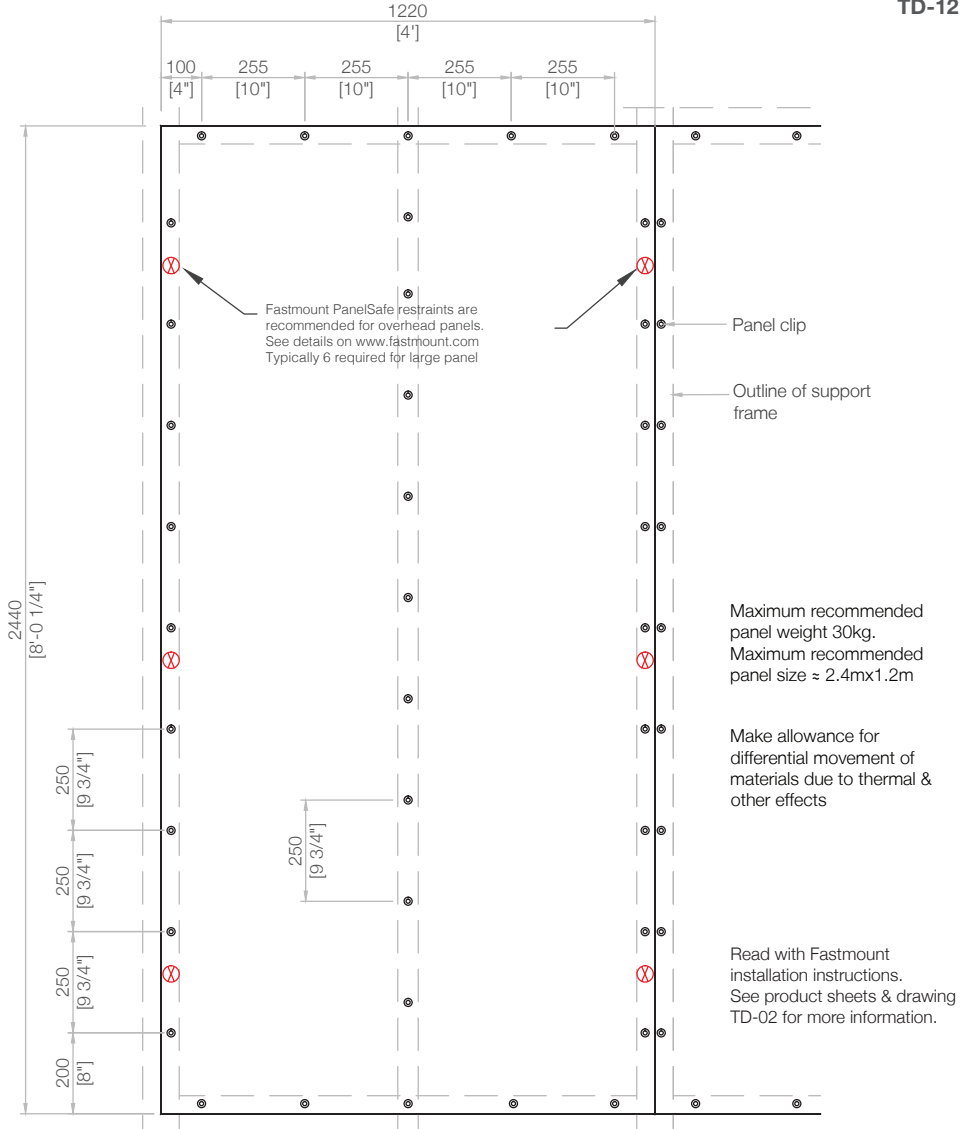

LAYOUT GUIDE FOR LARGE WALL PANEL STRATLOCK RANGE - SL-FA & SL-SFA

TD-15

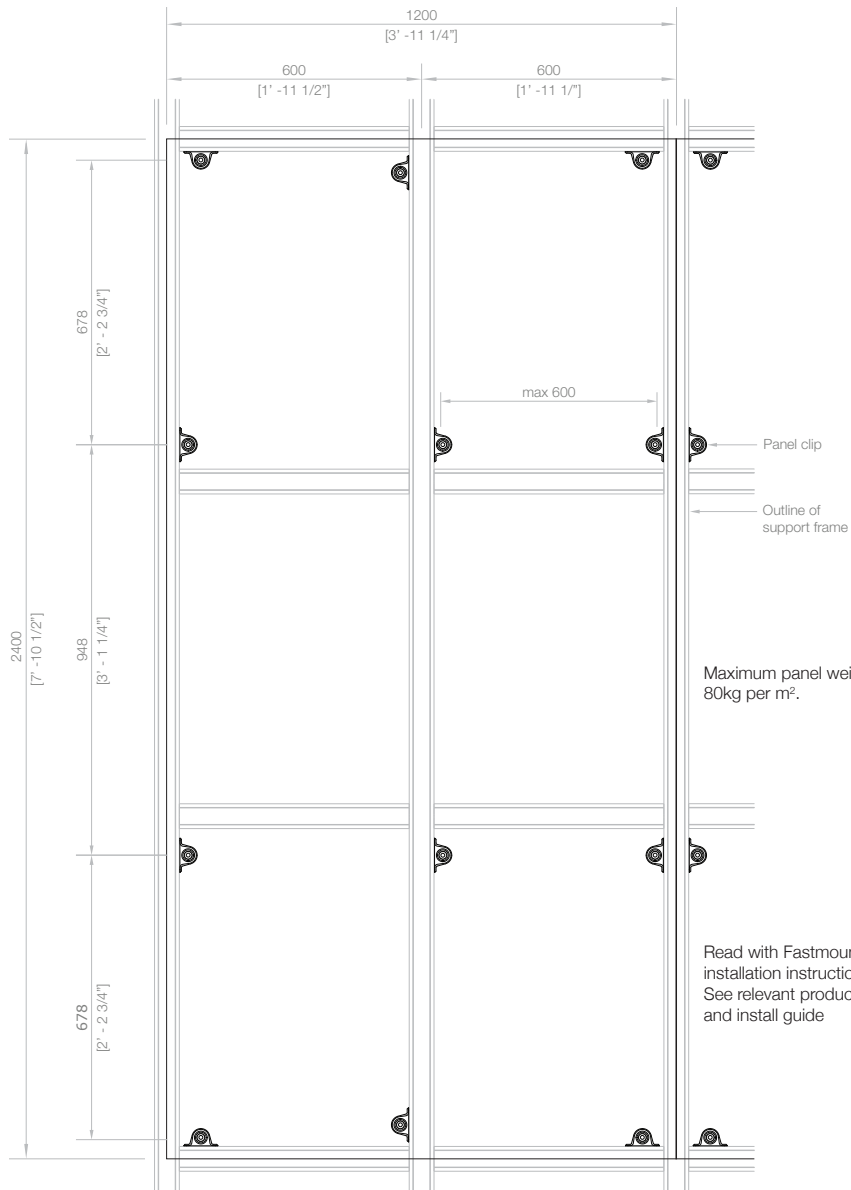

LAYOUT GUIDE FOR LARGE WALL PANEL STRATLOCK RANGE - SL-FB



TD-16

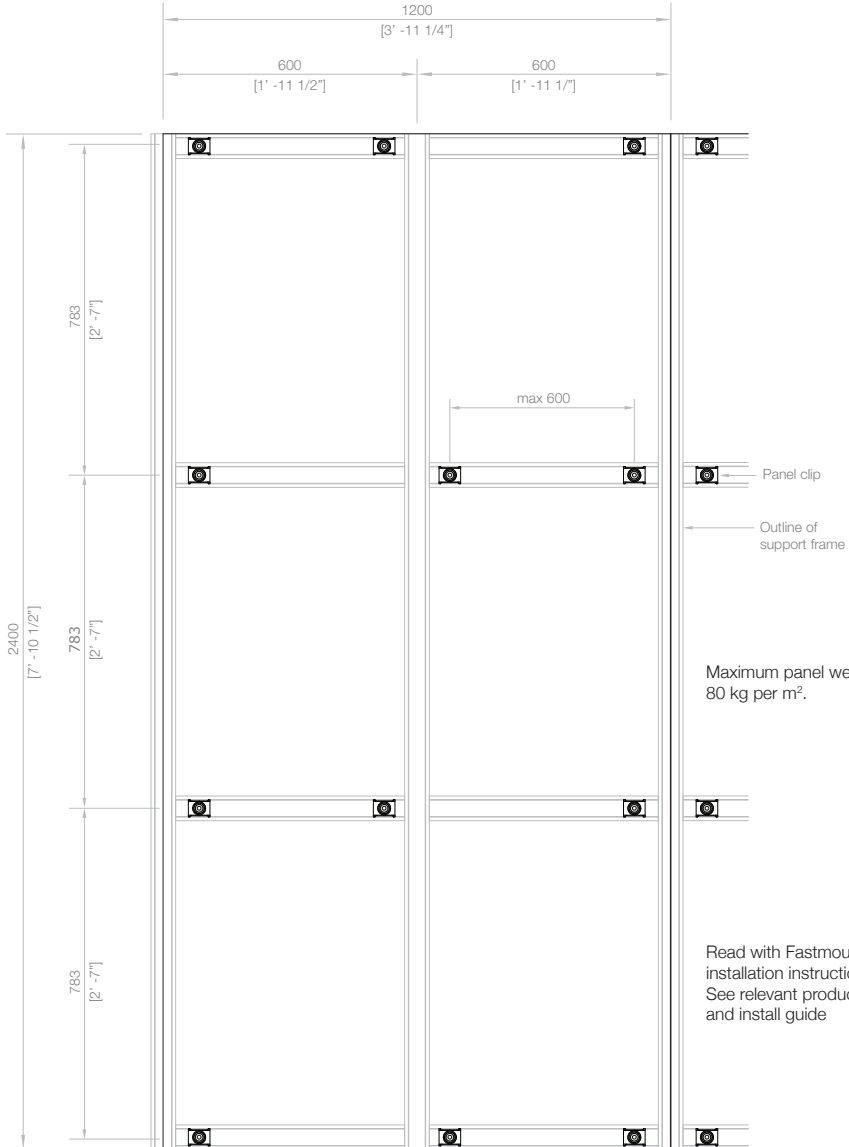

LAYOUT GUIDE FOR CEILING PANEL STRATLOCK RANGE - SL-FA & SL-SFA

TD-17

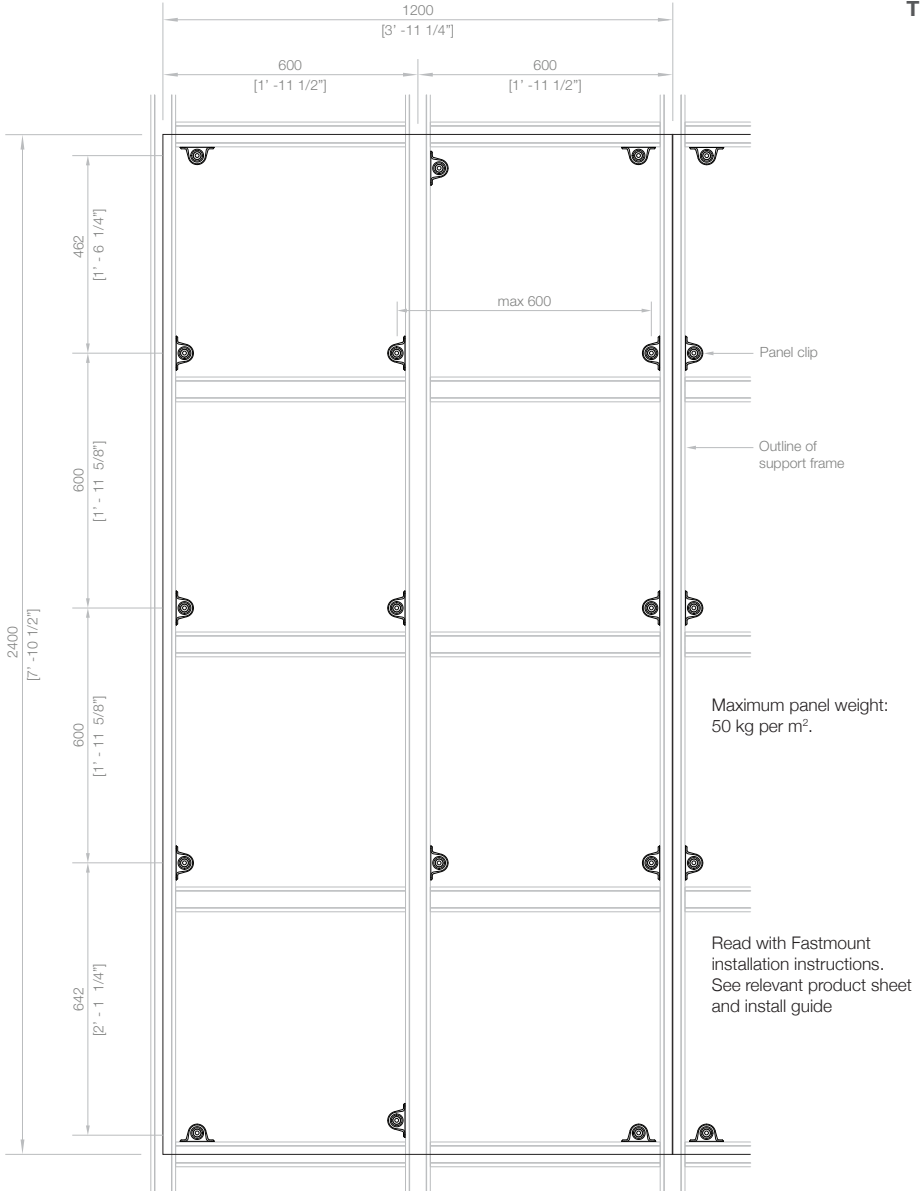

LAYOUT GUIDE FOR CEILING PANEL STRATLOCK RANGE - SL-FB



TD-18

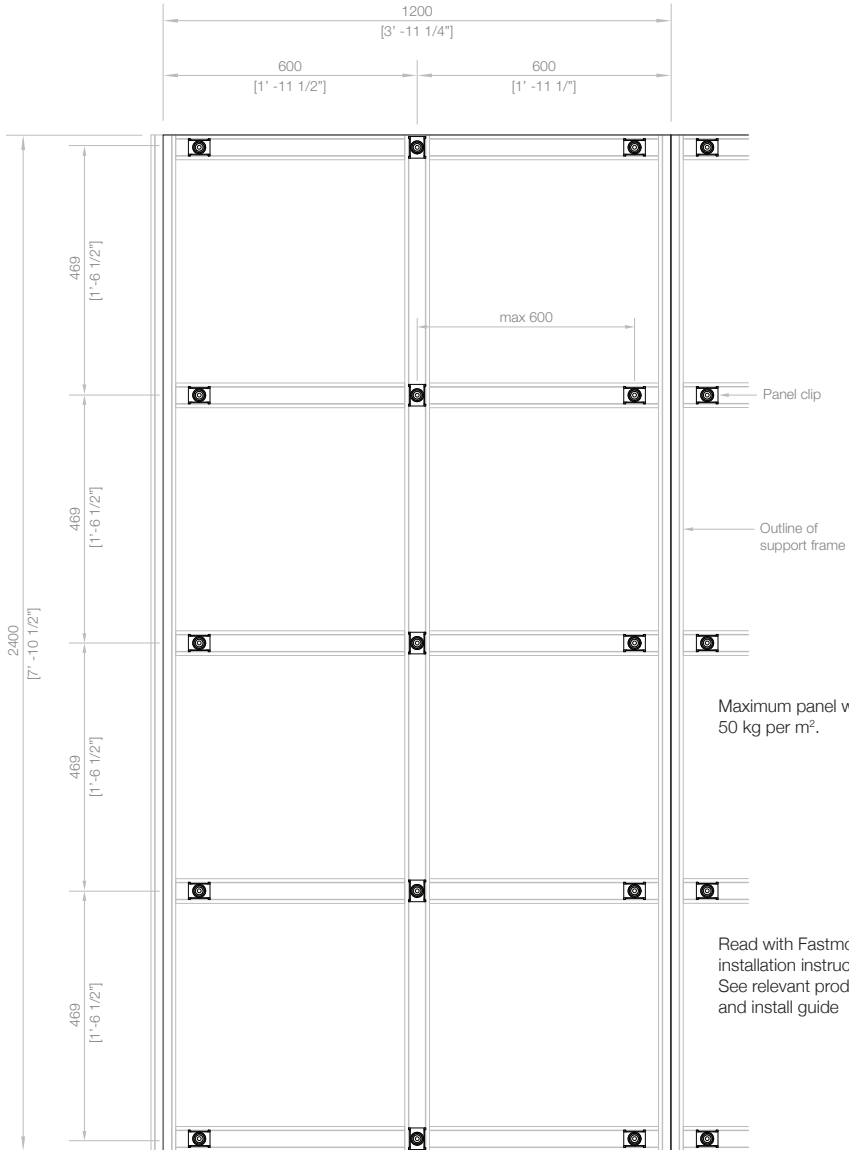

LAYOUT GUIDE FOR LARGE WALL PANEL STRATLOCK RANGE - SL-FC

TD-19

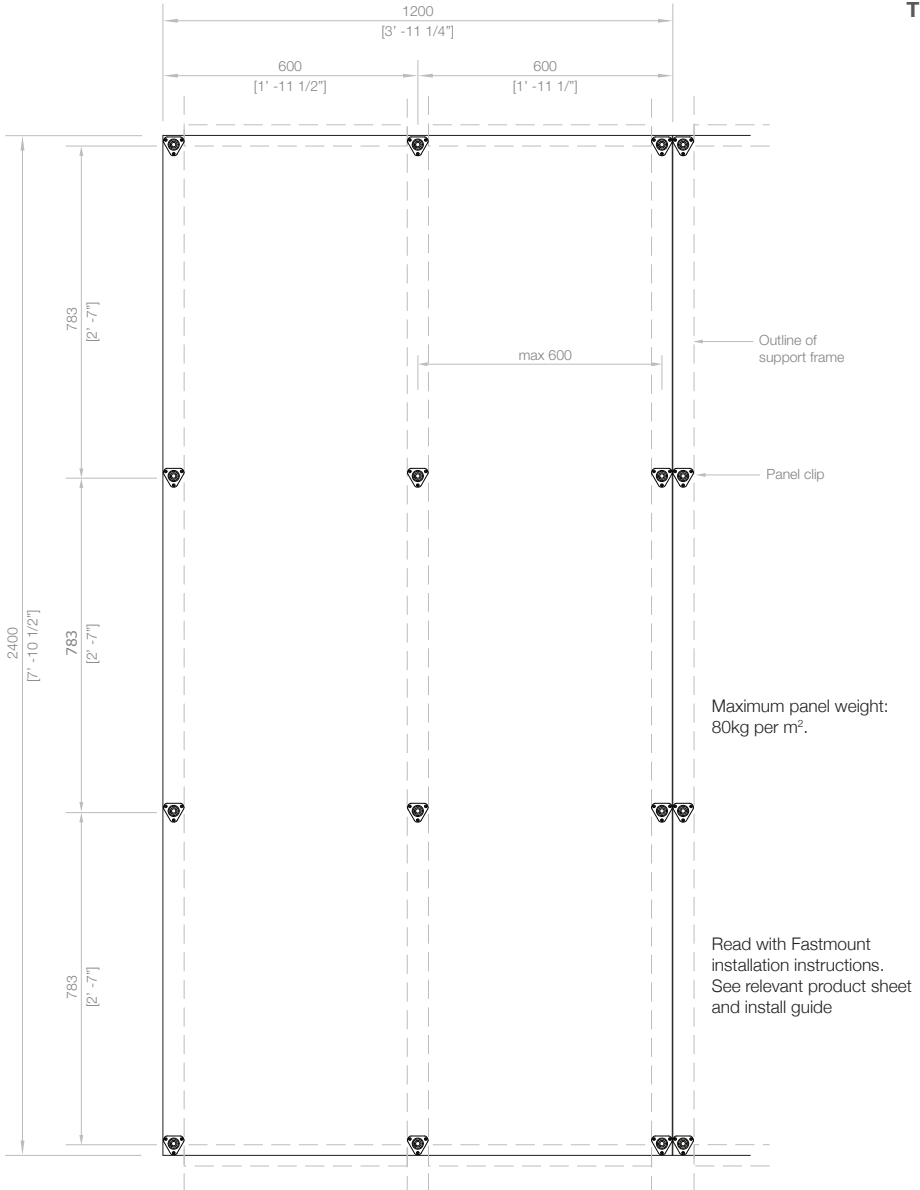

LAYOUT GUIDE FOR CEILING PANEL STRATLOCK RANGE - SL-FC



TD-20

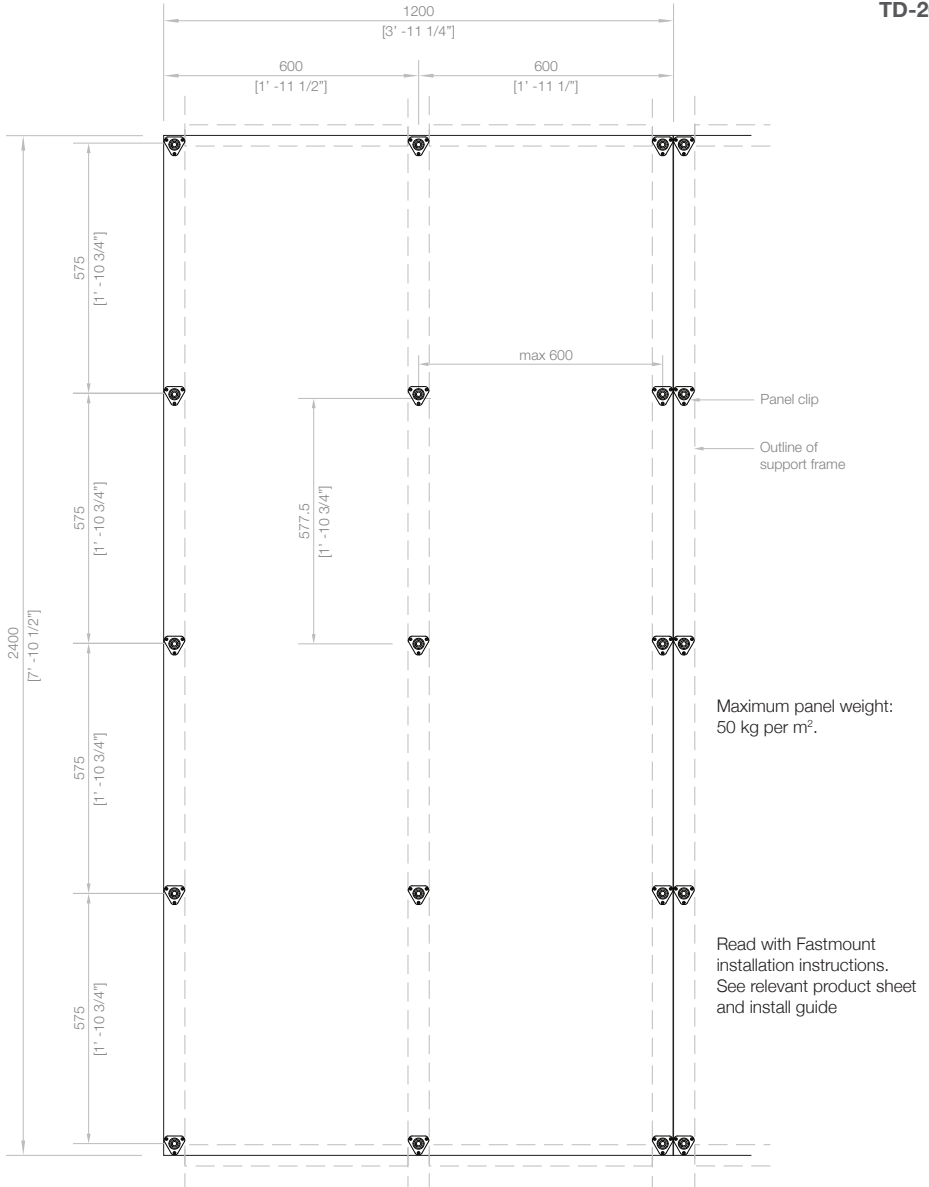

SELECTION GUIDE - ARCHITECTURAL

SUBSTRATE	Fibrous cement board	Exterior panel	PLYWOOD PANEL	MDF PANEL
TIMBER BATTENS OR FRAMES	N/A	N/A	PC-F1A / RF1 / AF1 + M1B / M2H / SM2H / VM1 VL-F3 / F3H + M3 / M3H SL-SFA + M18 MC-F5 / F10 + M5 LP-F8 / AF8A + M8A / SM8AS / SMX	PC-F1A / RF1 / AF1 + M1B / M2H / SM2H / VMX VL-F3 / F3H + M3 / M3H SL-SFA + M18 MC-F5 / F10 + M5 LP-F8 / AF8A + M8A / SM8AS / SMX
STEEL FRAMES e.g. Rondo	N/A	N/A	PC-SF1 + M1B / M2H / SM2 / SM2H VL-F3 / F3H + M3 / M3H MC-F5 / F10+ M5	PC-SF1 + M1B / SM2H / VMX VL-F3 / F3H / F3FR + M3 / M3H / M3FR MC-F5 / F10 + M5
STEEL FRAMES (See page 64)	N/A	N/A	SL-FB + M18 - screw fix	SL-FB + M18 - screw fix
STRATLOCK RAIL SYSTEM BY FASTMOUNT (See Page 63)	N/A	N/A	SL-FA / FA-FR + SL-M18 / M18-FR with screw fix SL-FB / FB-FR + SL-M18 / M18-FR	SL-FA / FA-FR + SL-M18 / M18-FR with screw fix SL-FB / FB-FR + SL-M18 / M18-FR
CONCRETE	N/A	N/A	PC-DC1 + F1A + M1B / M2H / VM1 / VMX	PC-DC1 + F1A + M1B / M2H / VM1 / VMX
CONCRETE + TIMBER BATTEN	N/A	N/A	PC-F1A + M1B / M2H / SM2 / SM2H / VM1 / VMX LP-F8 / AF8A + M8A / SM8AS / SMX VL-F3 / F3H + M3 / M3H MC-F5 / F10 + MC-M5	PC-F1A + M1B / M2H / SM2 / SM2H / VM1 / VMX LP-F8 / AF8A + M8A / SM8AS / SMX VL-F3 / F3H + M3 / M3H MC-F5 / F10 + M5
DRYWALL e.g. Gib Board	N/A	N/A	PC-DC1 + F1A + VM1 / M2H / SM2H LP-DF8 + M8A / SM8AS	PC-DC1 + F1A + VM1 / M2H / SM2H LP-DF8 + M8A / SM8AS
PLYWOOD, MDF	N/A	N/A	PC-F1A / AF1 / SF1 + PC-M1B / M2H / SM2 / SM2H LP-F8 / AF8A + M8A / SM8A / SMX VL-F3 / F3H + M3 / M3H MC-F5 / F10 + M5	PC-F1A / AF1 / SF1 + M1B / M2H / SM2 / SM2H LP-F8 / AF8A + M8A / SM8AS / SMX VL-F3 / F3H + M3 / M3H MC-F5 / F10 + M5

This Clip Selection Guide should be used as a general guide only. Please email technical@fastmount.com for more detailed advice if required. For overhead panels Fastmount strongly recommends a trial sample be made to prove compatibility of our systems with the panels and substrates in your project.



PARTICLE BOARD	ACOUSTIC PANEL	HONEYCOMB PANEL
PC-F1A / AF1 + VM1 / M2H VL-F3 / F3H + M3/ M3H LP-F8 / AF8A + SM8AS / SMX	PC-F1A / RF1 / AF1 / SF1 + SM1AC	PC-F1A / RF1 / SF1 / AF1 + SM2 / SM2H LP-F8 + SM8AS MC-F5 / F10 + MC-SM5 / SM5-VHBFR LP-F8 / AF8A + SM8AS / SMX
PC-SF1 + M1B / SM2H (+ glue thread)	PC-SF1 + SM1AC	PC-SF1 + SM2 VL-F3 / F3H / F3FR + M3 / M3H / M3FR MC-F5 / F10 + MC-SM5 / SM5-VHBFR
SL-FB + M18 - screw and adhesive fix	N/A	SL-FB + M18 - screw and adhesive fix
SL-FA / FA-FR + SL-M18 / M18-FR with screw and adhesive fix SL-FB / FB-FR + SL-M18 / M18-FR	N/A	SL-FA / FA-FR + SL-M18 / M18-FR with screw and adhesive fix SL-FB / FB-FR + SL-M18 / M18-FR
PC-DC1 + F1A + M2H / VM1	PC-DC1 + F1A + SM1AC	PC-DC1 + F1A + SM2 / SM2H
PC-F1A + M2H / SM2 / SM2H LP-F8 / AF8A + M8A / SM8AS / SMX	PC-F1A + SM1AC	PC-F1A + SM2 LP-F8 / AF8A + SM8AS / SMX VL-F3 / F3H / F3FR + M3 / M3H / M3FR MC-F5 / F10 + MC-SM5 / SM5-VHBFR
PC-DC1 + F1A + VM1 / M2H LP-DF8 + M8A / SM8AS	PC-DC1 + F1A + SM1AC	PC-DC1 + F1A + SM2 / SM2H LP-DF8 + SM8AS - with epoxy glue
PC-F1A / AF1 / SF1 + M1B / M2H / SM2 / SM2H LP-F8 / AF8A + SM8AS / SMX VL-F3 / F3H + M3 / M3H	PC-F1A / AF1 / SF1 + SM1AC	LP-F8 + SM8AS / SMX - with epoxy glue LP-F8 / AF8A + SM8AS / SMX VL-F3 / F3H / M3FR + M3 / M3H / M3FR MC-F5 / F10 + MC-SM5 / SM5-VHBFR

SELECTION GUIDE - MARINE

SUBSTRATE	PLYWOOD PANELS <6MM	PLYWOOD PANELS >6MM	SYNTHETIC PANELS (FOREX) <6MM
PLYWOOD FRAMES (or CNC cut plywood ceiling frame work)	PC-F1A / AF1 / SF1 + SM2 VL-F3 + M3 LP-F8 + SM8AS	PC-F1A + M1B / M2H / SM2 / SM2H/ VM1 / VMX LP-F8 + M8A / SM8AS / SMX VL-F3 / F3H + M3 / M3H MC-F5 / F10 + M5	PC-F1A + SM2 LP-F8 + SM8AS VL-F3 + M3
ALUMINIUM FRAMES	PC-RF1 / SF1+ SM2 VL-F3 + M3	PC-F1A / SF1 / RF1 + M1B / M2H / SM2 / SM2H/ VM1 / VMX VL-F3 / F3H + M3 / M3H MC-F5 / F10 + M5 SL-FA + M18	PC-F1A + SM2 LP-F8 + SM8AS VL-F3 + M3H
COMPOSITE SUBSTRATE	PC-SF1 + SM2 VL-F3 + M3	PC-SF1 / RF1 + SM2 / SM2H VL-F3 / F3H + M3 / M3H MC-F5 / F10 + M5	PC-SF1 / RF1 + SM2 VL-F3 + M3
STEEL FRAMES	PC-SF1 + SM2 VL-F3 + M3	PC-SF1 / RF1 + SM2 / SM2H VL-F3 / F3H + M3/M3H MC-F5 / F10 + M5	PC-SF1/RF1 + SM2 VL-F3 + M3
STRATLOCK RAIL SYSTEM BY FASTMOUNT	SL-FA + SL-M10 SL-FB + SL-M10	SL-FA / FA-FR + SL-M18 / M18-FR SL-FB / FB-FR + SL-M18 / M18-FR	SL-FA + SL-M10 SL-FB + SL-M10 Screw or adhesive fix male

This Clip Selection Guide should be used as a general guide only. Please contact email technical@fastmount.com for more detailed advice if required. For overhead panels Fastmount strongly recommends a trial sample be made to prove compatibility of our systems with the panels and substrates in your project.

**SYNTHETIC PANELS
(FOREX) >6MM**

PC-F1A + M1B / M2H / SM2 / SM2H / VM1 / VMX

LP-F8 + M8A / SM8S / SMX

VL-F3 / F3H + M3/M3H

MC-F5 / F10 + M5

**HONEYCOMB PANELS
(ALUMINIUM)**

PC-F1A + SM2 / SM2H

LP-F8 + SM8AS / SMX

VL-F3 / F3H + M3 / M3H

MC-F5 + MC-SM5 / SM5-VHBFR

**COMPOSITE PANELS
(FOAM CORE GRP)**

PC-F1A / AF1 / SF1 + SM2 / SM2H

VL-F3 / F3H + M3/M3H

LP-F8 + SM8AS / SMX

PC-F1A / SF1 / RF1 + M1B / M2H / SM2 / SM2H / VM1 / VMX

VL-F3 / F3H + M3 / M3H

MC-F5 / F10 + M5

SL-FA + M18

PC-F1A / SF1 / RF1 + SM2 / SM2H

VL-F3 / F3H / F3FR + M3 / M3H / M3FR

MC-F5 + MC-SM5 / SM5-VHBFR

PC-RF1 / SF1 / F1A + SM2 / SM2H / SMX

VL-F3 + M3

SL-FA + M18

PC-SF1 / RF1 + M1B / M2H / SM2 / SM2H / VM1 / VMX

VL-F3 / F3H + M3 / M3H

MC-F5 / F10 + M5

PC-SF1 / RF1 + SM2

VL-F3 / F3H + M3 / M3H

MC-F5 + MC-SM5 / SM5-VHBFR

PC-SF1 / RF1 + SM2 / SM2H

VL-F3 + M3

MC-F5 / F10 + MC-SM5 / SM5-VHBFR

PC-SF1 / RF1 + M1B / M2H / SM2 / SM2H / VM1 / VMX

VL-F3 + M3/M3

MC-F5 / F10 + M5

PC-SF1 / RF1 + SM2

VL-F3 + M3/M3H

MC-F5 + MC-SM5 / SM5-VHBFR

PC-SF1 / RF1 + SM2 / SM2H

VL-F3 + M3

MC-F5 / F10 + MC-SM5 / SM5-VHBFR

SL-FA + SL-M18

SL-FB + SL-M18

SL-FA / FA-FR + SL-M18 / M18-FR

SL-FB / FB-FR + SL-M18 / M18-FR

SL-FA / FA-FR + SL-M18 / M18-FR

SL-FB / FB-FR + SL-M18 / M18-FR

PANEL OFFSET GUIDE - PC/LP/VL/MC

	GAP	LOAD KG	SHEAR KGF	GAP	LOAD	SHEAR
STANDARD RANGE	PC-F1A			PC-F1A + PC-DC1		
PC-M1B	4mm	5	85	4.5 - 10.5mm	5	85
PC-M2H	4mm	10	64	4.5 - 10.5mm	10	64
PC-VM1	4mm	5	113	4.5 - 10.5mm	5	113
PC-VMX	4mm	15	153	4.5 - 10.5mm	15	153
PC-SVMX	4mm	15	-	4.5 - 10.5mm	15	-
PC-SM2	4.2mm	5	40	4.7 - 10.5mm	5	40
PC-SM2H	4.2mm	10	68	4.7 - 10.5mm	10	68
PC-SM1AC	4mm	2	n/a	4.5 - 10.5mm	2	n/a
LOW PROFILE RANGE	LP-F8			LP-DF8		
LP-M8A	4.1mm	5	104.7	4.1mm	5	88
LP-SM8AS	4.3mm	5	56.9	4.3mm	5	62.6
LP-SMX	3.8mm	15	79	n/a	n/a	n/a
VERY LOW PROFILE RANGE	VL-F3 (RECESSED)			VL-F3 (SURFACE MOUNTED)		
VL-M3	3mm	5	88	10mm	5	88
VL-M3H	-	-	-	-	-	-
VL-M3FR	-	-	-	-	-	-
METAL RANGE	MC-F5			MC-F10		
MC-M5	4mm	5	1050	4mm	10	945
MC-SM5	3.75mm	5	135.9	3.75mm	10	119.6
MC-SM5-VHB	4.75mm	5	40.4	4.75mm	10	41.3



GAP LOAD SHEAR			GAP LOAD SHEAR			GAP LOAD SHEAR		
PC-SF1			PC-RF1			PC-AF1		
17.4mm	5	72	0 - 2mm	5	72	4mm	5	68
17.4mm	10	55	0 - 2mm	10	55	4mm	10	75
17.4mm	5	96	0 - 2mm	5	96	4mm	5	118
17.4mm	15	120	0 - 2mm	15	120	4mm	15	154
17.4mm	15	-	0 - 2mm	15	-	4mm	15	-
17.6mm	5	46	0 - 2.2mm	5	46	4.2mm	5	43
17.6mm	10	52	0 - 2.2mm	10	52	4.2mm	10	44
17.4mm	2	n/a	0 - 2mm	2	n/a	4mm	2	n/a

LP-AF8A		
4.1mm	5	136.9
4.3mm	5	105.3
3.8mm	15	142

VL-F3H (RECESSED)			VL-F3H (SURFACE MOUNTED)			VL-F3FR (RECESSED)			VL-F3FR (SURFACE MOUNTED)		
-			-			-			-		
3mm	10	101	10mm	10	101	-			-		
-	-	-	-	-	-	3mm	10	107	10mm	10	107

PANEL OFFSET GUIDE - SL/TC

	GAP	LOAD KG	SHEAR KGF	GAP	LOAD	SHEAR
SL RANGE + STRATLOCK RAIL SYSTEM (Front face of rail to back face of panel)	SL-FA			SL-SFA		
SL-M18 (First click)	12.5mm	n/a	n/a	12.5mm	n/a	n/a
SL-M18 (Second click)	6mm	18	142	6mm	18	-
SL-M10 (First click)	12.5mm	n/a	n/a	12.5mm	10	n/a
SL-M10 (Second click)	6mm	10	117.2	6mm	10	130
SL RANGE + STRATLOCK RAIL SYSTEM (Back of rail to back face of panel)						
SL-M18 (First click)	34.8mm	n/a	n/a	n/a		
SL-M18 (Second click)	28.3mm	18	142	n/a		
SL-M10 (First click)	34.8mm	n/a	n/a	n/a		
SL-M10 (Second click)	28.3mm	10	142	n/a		
TEXTILE RANGE	TC-F6H					
TC-M6		26	-			
TC-SM6		32	-			
TC-SM6S		32	-			



SL-FB			SL-FC		
GAP	LOAD	SHEAR	GAP	LOAD	SHEAR
12.5mm	n/a	n/a	13.5mm	n/a	n/a
6mm	18	89	7mm	18	181.4
12.5mm	n/a	n/a	13.5mm	n/a	n/a
6mm	10	95.6	7mm	10	181.4

38.3	n/a	n/a	n/a
31.8	18	89	n/a
38.3	n/a	n/a	n/a
31.8	10	89	n/a

FREQUENTLY ASKED QUESTIONS

Q. Can I use the Fastmount® system on prefinished panels or painted panels?

Yes. Install with the correct centre points and drill bits for the clip range you are using. These will allow you to align the clips in the panels with the clips in the substrate. See our install videos at www.fastmount.com to see this technique in action.

Q. Is the self tapping clip suitable for hardwood?

It is very variable depending on the hardwood selected, and even on the particular batch of hardwood. Some customers successfully friction fix into an 11mm hole rather than a 10mm hole with the addition of some adhesive in the hole.

Q. Can I mount Fastmount clips into other materials such as fibreglass?

Yes. With the PC-F1A, you will need to use the CT-15 Thread Tap to create a thread in the hole. A small countersink to the entrance edge of the hole will help the clip screw in neatly.

Q. Can self tapping standard and low profile clips be screwed into hardwoods and high pressure laminates e.g. MDF and fibreglass?

The following three options are recommendations only, as panel and substrate density can vary considerably. NB: A test panel should be mounted prior to large scale use.

Option 1: For MDF type panels or substrates, and medium to high density plywood

Once the hole has been drilled for the clip in question, countersink the entrance to the hole to a depth of 1.5mm max. Then, using a battery drill and the correct install tool, screw the clip into the hole while exerting a lot of pressure onto the battery drill.

Option 2: For very dense hardwood panels and substrates

For the male clips, LP-M8A substitute the 10mm hole size with a 10.5-11mm hole. Apply some epoxy glue to the threads of the clip and using a battery drill with the correct install tool (CT-10) screw the clip into the hole, while exerting pressure onto the battery drill.

The drill size will vary depending on density of panel, so you will need to test a sample piece to ascertain the correct drill size for your project.

Option 3: For very dense hardwoods

Use a surface mount male clip. Match this clip with the female clip mounted in the frame or substrate.

Alternatively, use the MC-05 metal clip system. The metal construction means it will screw into most hard materials including solid fibreglass.

Q. Can I use fewer clips if the panel weighs less than the combined pull out load of the clips on my panel?

No. It is important to view the TD Clip Layout Guides, which are designed to allow for even distribution of the clips, so that the panel is held securely and evenly to ensure a flawless appearance. In calculating the TD Clip Layout Guides, we do our best to include factors like possible seismic g-forces, impact, flexing and thermal expansion.



Placing your clips excessively wide, such as 600mm apart, or using too few clips may contribute to the panel sagging slightly between the clips, depending on the panel stiffness. See the TD Clip Layout Guides on previous pages which show correct clip spacing for the various panel types.

Q. How much space is required between Fastmount clip sets?

Refer to the TD Clip Layout Guides for recommended clip set spacing for removable ceiling and wall panels and for large, heavy or small, light-weight panels.

For clip set spacing recommendations for other applications please email technical@fastmount.com.

Q. Will panels sag over time?

No, not if the clips are installed with the proper spacing. Placing your clips excessively wide, around the perimeter of a 6-12mm thick ceiling panel, over 400mm apart, or using too few clips may contribute to the panel sagging slightly between the clips, depending on your panel stiffness.

See the TD Clip Layout Guides on previous pages which show correct clip spacing for the various panel types.

Q. Why are the panels not fitting correctly?

Check the clip alignment. If the panels are fabric covered, check that allowance has been made for the correct thickness of the fabric on the edge of the panels, and check that the 10mm drill hole is square to face.

Q. Why do clips occasionally break?

As male clips can be broken due to mishandling, please ensure male clips are not installed until the final fit. We recommend that you regularly monitor the diameter of the female hole drilled out by the CT-07. If it is less than 16.8mm, undue tension will be applied to the female part of clip when screwed into place. This puts pressure on the male part of clip which may cause occasional breakages. NB: do not use standard 16mm drill bits as these will cause breakages.

Q. If the front face of the panel is veneered and/or painted, should the other side of the panel with Fastmount clips fitted have the same?

Yes, panels must be balanced. If a panel is not painted, sealed or veneered equally on both faces, the panel is considered unbalanced and is likely to distort, cup or twist, exerting tremendous pressure on the mounting system. This can lead to the centre of large panels 'popping' off as the clips struggle to withstand this cupping or warping pressure. Sealing or veneering both sides so that the panel is structurally stable is simply good practice. Fastmount can provide advice but is not responsible for the unclipping of clips due to distorted panels.

Q. Does the Fastmount panel mounting system have a warranty?

Yes, the Fastmount panel mounting system has a comprehensive 2 year warranty. View our warranty online.

MAINTENANCE GUIDE

Maintenance of panels mounted with Fastmount clip systems

Fastmount clips have been designed to be removed and refitted easily. The clips are hidden when in place and require no special maintenance. The Fastmount panel mounting system allows for easy access to maintain wiring, electronics and plumbing in the substrate, as well as access to storage behind the panels.

To remove panels

Use cotton gloves when handling panels.

Covered panels should be removed using the CT-05 panel removal tool introduced at the corner edge of the panel and then pulling the panel gently away from the support frame, slowly disengaging each line of clips.

Painted or prefinished panels should be removed using two of the CT-17 glass suckers or the CT-05H heavy duty removal tool using the attached hook.

NOTE: if the panels are very long, wide or heavy always ensure that 2 people handle the panel for safety and to minimize extreme pressure on the clips.

Clip breakage

If the panel male clip breaks (typically due to extreme oblique pressure, extreme g-forces, or rough handling) the clip can be replaced easily and quickly with the CT-06 Service Kit which contains installation tools, CT-05 panel removal tool and a number of replacement clips.

To refit panels

Use cotton gloves when handling panels. Present the panel up to the original panel space and firmly push panels into place ensuring all clips are engaged. Use a firm pressure, do not hit the panel hard with your hand to engage clips – this can cause damage to the panels and the clips.

Tool maintenance

Periodically coat the drill bits in tooling oil (not supplied).

For further information please refer to the Fastmount Installation Guides.

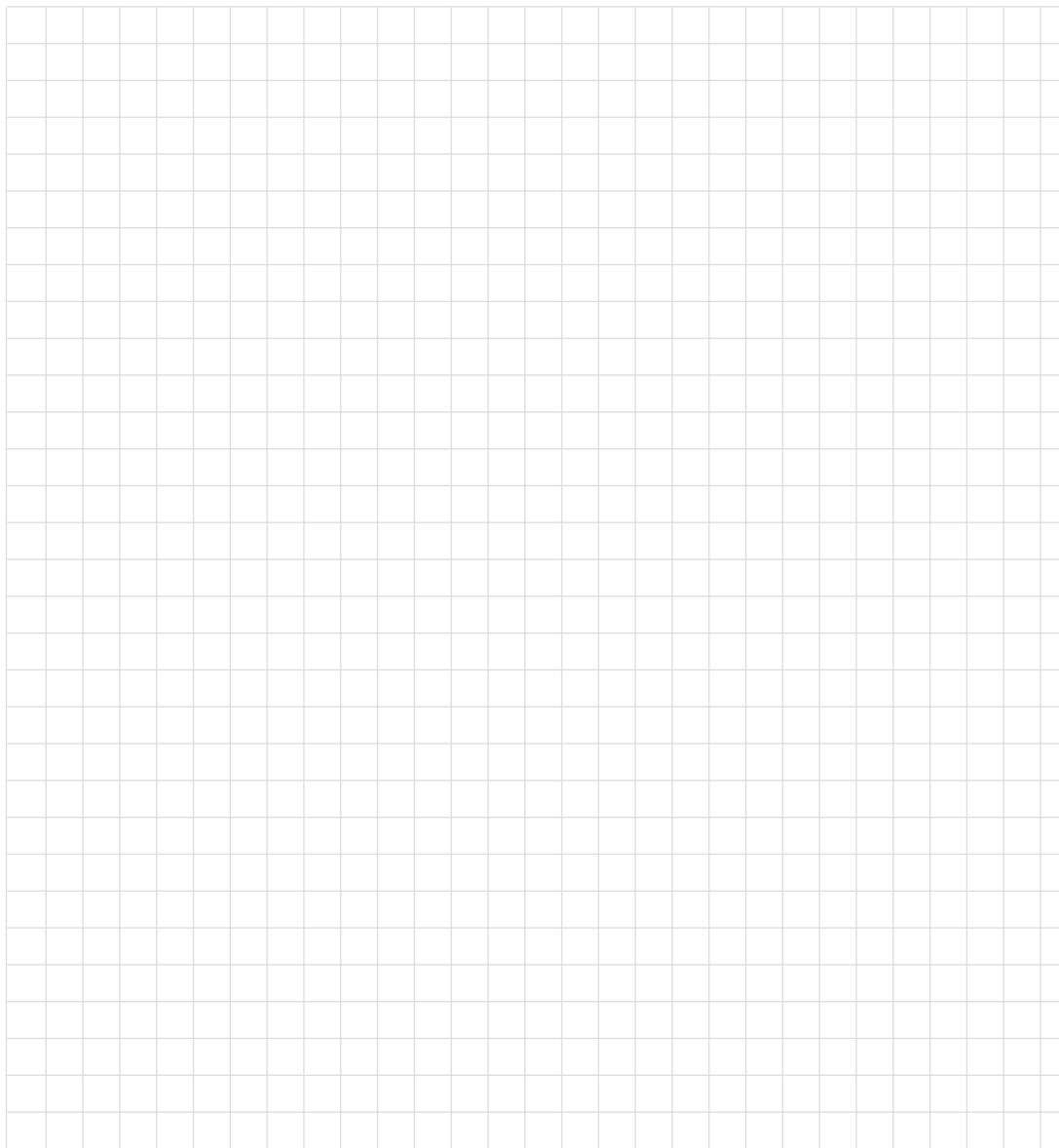

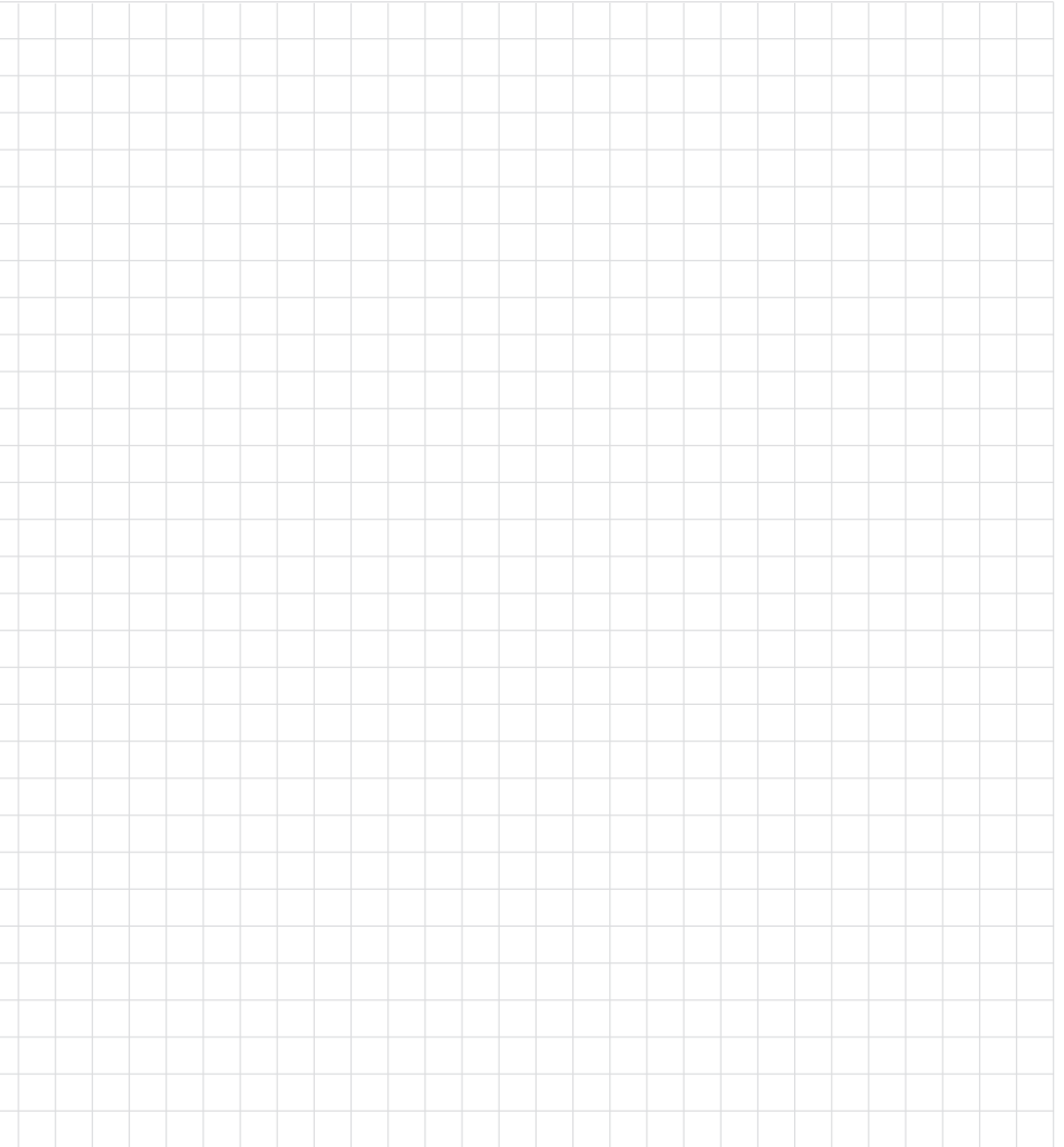

FASTMOUNT AUTHORISED DISTRIBUTORS

AFRICA

Dynamic Supply Systems (DSS)
+27 (0)82 387 5324

AUSTRALIA

MarineWare
+61 (7) 5502 8966

Titus Tekform Pty Ltd
+61 (02) 9826 0007

AUSTRIA & GERMANY
Robert Lindemann KG
+49 (0)40 211197 20

BAHRAIN, KUWAIT,
SAUDI ARABIA & UAE
Exalto Emirates LLC
+971 (0)6 545 3366

BELARUS

Furniplast
+37 5296 650065

BRAZIL

I-Sea
+5511 9 9922.5505

CANADA

Western Marine
+1 604 253 3322
Sugatsune Canada Inc
+1-514-312-5267

CHILE

Rce latam
+56 9 3467 9401

CHINA

Sugatsune Shanghai
+86-21-3632-1858 extrn 802

CROATIA

Yachthings
+385 52 63 56 15

DENMARK

HF Industri & Marine
+45 6220 1312

ESTONIA

Gamma Baltic OÜ
+372 6459757

FINLAND

MarineMan Oy
+358 10 4235220

FRANCE

Domarine
+33(6)72 808 185

GREECE

VIOTAP
+30 210 24 65 510

HUNGARY

Kerimpex Kft.
+36 1 3330010

INDIA

Sugatsune Kogyo India
+91-22-2831-4490 & 4491

ITALY

Promotech Italia Srl
+39 0584 55 026

JAPAN

Sugatsune Co Ltd
+81 (03) 3866-2267

KOREA

Young & Sun Int'l Inc.
+82 31 716 7994

LATVIA

Gamma Fittings SIA
+371 29207538

LITHUANIA

UAB Furnitanas
+37052323052

NETHERLANDS

Kroon B.V.
+31 (0) 598-858585

NEW ZEALAND

QCD Ltd
+64 09 815 7500

POLAND

Nowacore
+48 504 071 930

RUSSIA

New Furniture Technologies Ltd
+7 (812) 703 01 13

SINGAPORE

Beltiston Ventures Pte Ltd
+65 6367 3148

SPAIN

Riviera Trade
+34 606 959 967

SWEDEN

HF Marin Sweden AB
+46 550 77 11 11

TAIWAN

Asia Connect
+886 07 2229224

THAILAND

Brand House Asia
+66 (0)76527 772

TURKEY

Neva Marine
+90 (216) 447 0600

UK

Sugatsune Kogyo(UK) Ltd
+44 (0) 1189 272 955

UKRAINE

Mebelnye Technology
+3804444923000

USA

Spradling Int'l Marine
+1 800 967 7753
Sugatsune America
+1 800-562-5267

TECHNICAL SUPPORT

AUSTRALASIA

Fastmount Ltd
+64 21725418

EUROPEAN UNION

Domarine
+33 (0) 672 808185

UK

Sugatsune Kogyo (UK) Ltd
+44 (0) 1189 272 955

USA & CANADA

Sugatsune America, Inc
+1 (310) 329-6373



FASTMOUNT RANGE OVERVIEW

STANDARD PC RANGE

Please note, some products are not to scale

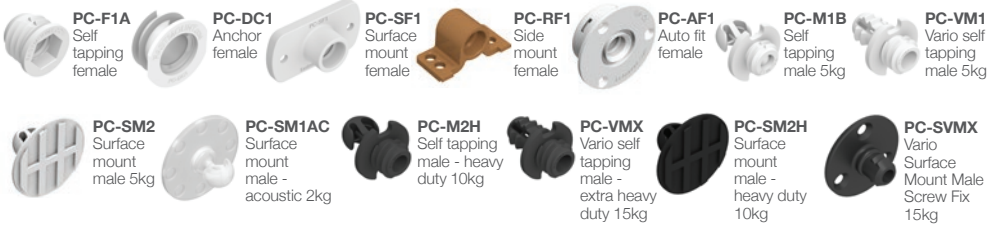

LOW PROFILE LP RANGE



VERY LOW PROFILE VL RANGE



STRATLOCK SL RANGE - fire-rated versions available



METAL MC RANGE

TEXTILE TC RANGE



PANELSAFE PS RANGE RANGE



fastmount.com



Supplying to thousands of companies in over 50 countries, the Fastmount® Panel Mounting System offers exceptional panel mounting solutions for the marine, architectural, aviation and recreational vehicle industries. Its global network of distributors ensures easy accessibility to the Fastmount system worldwide.

Visit fastmount.com to see new products, download CAD files or find your nearest distributor.

SGS TESTED | RELIABLE | ORIGINAL
SPECIFY FASTMOUNT



PROUDLY DESIGNED & MANUFACTURED IN NEW ZEALAND

Copyright © 2021 Fastmount